



Standard Guide for Magnetic Particle Testing¹

This standard is issued under the fixed designation E709; the number immediately following the designation indicates the year of original adoption or, in the case of revision, the year of last revision. A number in parentheses indicates the year of last reapproval. A superscript epsilon (ϵ) indicates an editorial change since the last revision or reapproval.

This standard has been approved for use by agencies of the Department of Defense.

1. Scope

1.1 This guide² describes techniques for both dry and wet magnetic particle testing, a nondestructive method for detecting cracks and other discontinuities at or near the surface in ferromagnetic materials. Magnetic particle testing may be applied to raw material, semifinished material (billets, blooms, castings, and forgings), finished material and welds, regardless of heat treatment or lack thereof. It is useful for preventive maintenance testing.

1.1.1 This guide is intended as a reference to aid in the preparation of specifications/standards, procedures and techniques.

1.2 This guide is also a reference that may be used as follows:

1.2.1 To establish a means by which magnetic particle testing, procedures recommended or required by individual organizations, can be reviewed to evaluate their applicability and completeness.

1.2.2 To aid in the organization of the facilities and personnel concerned in magnetic particle testing.

1.2.3 To aid in the preparation of procedures dealing with the examination of materials and parts. This guide describes magnetic particle testing techniques that are recommended for a great variety of sizes and shapes of ferromagnetic materials and widely varying examination requirements. Since there are many acceptable differences in both procedure and technique, the explicit requirements should be covered by a written procedure (see Section 21).

1.3 This guide does not indicate, suggest, or specify acceptance standards for parts/pieces examined by these techniques. It should be pointed out, however, that after indications have been produced, they must be interpreted or classified and then evaluated. For this purpose there should be a separate code, specification, or a specific agreement to define the type, size, location, degree of alignment and spacing, area concentration,

and orientation of indications that are unacceptable in a specific part versus those which need not be removed before part acceptance. Conditions where rework or repair is not permitted should be specified.

1.4 This guide describes the use of the following magnetic particle method techniques.

1.4.1 Dry magnetic powder (see 8.4),

1.4.2 Wet magnetic particle (see 8.5),

1.4.3 Magnetic slurry/paint magnetic particle (see 8.5.7), and

1.4.4 Polymer magnetic particle (see 8.5.8).

1.5 *Personnel Qualification*—Personnel performing examinations in accordance with this guide should be qualified and certified in accordance with ASNT Recommended Practice No. **SNT-TC-1A**, ANSI/ASNT Standard **CP-189**, **NAS 410**, or as specified in the contract or purchase order.

1.6 *Nondestructive Testing Agency*—If a nondestructive testing agency as described in Practice **E543** is used to perform the examination, the nondestructive testing agency should meet the requirements of Practice **E543**.

1.7 The numerical values shown in inch-pound units are to be regarded as the standard. SI units are provided for information only.

1.8 *This standard does not purport to address all of the safety concerns, if any, associated with its use. It is the responsibility of the user of this standard to establish appropriate safety and health practices and determine the applicability of regulatory limitations prior to use.*

2. Referenced Documents

2.1 *ASTM Standards*:³

A275/A275M [Practice for Magnetic Particle Examination of Steel Forgings](#)

A456/A456M [Specification for Magnetic Particle Examination of Large Crankshaft Forgings](#)

D93 [Test Methods for Flash Point by Pensky-Martens Closed Cup Tester](#)

D445 [Test Method for Kinematic Viscosity of Transparent](#)

¹ This guide is under the jurisdiction of ASTM Committee E07 on Nondestructive Testing and is the direct responsibility of Subcommittee E07.03 on Liquid Penetrant and Magnetic Particle Methods.

Current edition approved Feb. 15, 2008. Published April 2008. Originally approved in 1980. Last previous edition approved in 2001 as E709-01. DOI: 10.1520/E0709-08.

² For ASME Boiler and Pressure Vessel Code Applications see related Guide SE-709 in Section II of that Code.

³ For referenced ASTM standards, visit the ASTM website, www.astm.org, or contact ASTM Customer Service at service@astm.org. For *Annual Book of ASTM Standards* volume information, refer to the standard's Document Summary page on the ASTM website.

and Opaque Liquids (and Calculation of Dynamic Viscosity)

E165 Practice for Liquid Penetrant Examination for General Industry

E543 Specification for Agencies Performing Nondestructive Testing

E1316 Terminology for Nondestructive Examinations

E1444 Practice for Magnetic Particle Testing

E2297 Guide for Use of UV-A and Visible Light Sources and Meters used in the Liquid Penetrant and Magnetic Particle Methods

2.2 *Society of Automotive Engineers (SAE): Aerospace Materials Specifications:*⁴

AMS 2300 Premium Aircraft Quality Steel Cleanliness Magnetic Particle Inspection Procedure

AMS 2301 Aircraft Quality Steel Cleanliness Magnetic Particle Inspection Procedure

AMS 2303 Aircraft Quality Steel Cleanliness Martensitic Corrosion Resistant Steels Magnetic Particle Inspection Procedure

AMS 2641 Vehicle Magnetic Particle Inspection

AMS 3040 Magnetic Particles, Non-fluorescent, Dry Method

AMS 3041 Magnetic Particles, Non-fluorescent, Wet Method, Oil Vehicle, Ready to Use

AMS 3042 Magnetic Particles, Non-fluorescent, Wet Method, Dry Powder

AMS 3043 Magnetic Particles, Non-fluorescent, Oil Vehicle, Aerosol Packaged

AMS 3044 Magnetic Particles, Fluorescent, Wet Method, Dry Powder

AMS 3045 Magnetic Particles, Non-fluorescent, Wet Method, Oil Vehicle, Ready to Use

AMS 3046 Magnetic Particles, Non-fluorescent, Wet Method, Oil Vehicle, Aerosol Packaged

AMS 5062 Steel, Low Carbon Bars, Forgings, Tubing, Sheet, Strip, and Plate 0.25 Carbon, Maximum

AMS 5355 Investment Castings

AMS-I-83387 Inspection Process, Magnetic Rubber

AS 4792 Water Conditioning Agents for Aqueous Magnetic Particle Inspection

AS 5282 Tool Steel Ring Standard for Magnetic Particle Inspection

AS 5371 Reference Standards Notched Shims for Magnetic Particle Inspection

2.3 *American Society for Nondestructive Testing:*⁵

SNT-TC-1A Personnel Qualification and Certification in Nondestructive Testing

CP-189 ASNT Qualification and Certification of Nondestructive Testing Personnel

2.4 *Federal Standards:*⁶

A-A-59230 Fluid, Magnetic Particle Inspection, Suspension
FED-STD 313 Material Safety Data Sheets Preparation and the Submission of

2.5 *OSHA Document:*⁷

29CFR 1910.1200 Hazard Communication

2.6 *AIA Documents:*⁸

NAS 410 Nondestructive Testing Personnel Qualification and Certification

3. Terminology

3.1 For definitions of terms used in the practice, refer to Terminology **E1316**

4. Summary of Guide

4.1 *Principle*—The magnetic particle method is based on establishing a magnetic field with high flux density in a ferromagnetic material. The flux lines must spread out when they pass through non-ferromagnetic material such as air in a discontinuity or an inclusion. Because flux lines can not cross, this spreading action may force some of the flux lines out of the material (flux leakage). Flux leakage is also caused by reduction in ferromagnetic material (cross-sectional change), a sharp dimensional change, or the end of the part. If the flux leakage is strong enough, fine magnetic particles will be held in place and an accumulation of particles will be visible under the proper lighting conditions. While there are variations in the magnetic particle method, they all are dependent on this principle, that magnetic particles will be retained at the locations of magnetic flux leakage. The amount of flux leakage at discontinuities depends primarily on the following factors; flux density in the material, and size, orientation, and proximity to the surface of a discontinuity. With longitudinal fields, all of the flux lines must complete their loops through air and an excessively strong magnetic field may interfere with examination near the flux entry and exit points due to the high flux-density present at these points.

4.2 *Method*—While this practice permits and describes many variables in equipment, materials, and procedures, there are three steps essential to the method:

4.2.1 The part must be magnetized.

4.2.2 Magnetic particles of the type designated in the contract/purchase order/specification should be applied while the part is magnetized or immediately thereafter.

4.2.3 Any accumulation of magnetic particles must be observed, interpreted, and evaluated.

4.3 *Magnetization:*

4.3.1 *Ways to Magnetize*—A ferromagnetic material can be magnetized either by passing an electric current through the material or by placing the material within a magnetic field originated by an external source. The entire mass or a portion of the mass can be magnetized as dictated by size and equipment capacity or need. As previously noted, in order to be detectable, the discontinuity must interrupt the normal path of the magnetic field lines. If a discontinuity is open to the

⁴ Available from Society of Automotive Engineers (SAE), 400 Commonwealth Dr., Warrendale, PA 15096-0001, <http://www.sae.org>.

⁵ Available from American Society for Nondestructive Testing (ASNT), P.O. Box 28518, 1711 Arlingate Ln., Columbus, OH 43228-0518, <http://www.asnt.org>.

⁶ Available from Standardization Documents Order Desk, DODSSP, Bldg. 4, Section D, 700 Robbins Ave., Philadelphia, PA 19111-5098, <http://www.dodssp.daps.mil>.

⁷ Available from Occupational Safety and Health Administration (OSHA), 200 Constitution Ave., NW, Washington, DC 20210, <http://www.osha.gov>.

⁸ Available from Aerospace Industries Association of America, Inc. (AIA), 1000 Wilson Blvd., Suite 1700, Arlington, VA 22209-3928, <http://www.aia-aerospace.org>.

surface, the flux leakage attracting the particles will be at the maximum value for that particular discontinuity. When that same discontinuity is below the surface, flux leakage evident on the surface will be a lesser value.

4.3.2 *Field Direction*—If a discontinuity is oriented parallel to the magnetic field lines, it may be essentially undetectable. Therefore, since discontinuities may occur in any orientation, it may be necessary to magnetize the part or the area of interest twice or more sequentially in different directions by the same method or a combination of different methods (see Section 13) to induce magnetic field lines in a suitable direction in which to perform an adequate examination.

4.3.3 *Field Strength*—The magnetic field must be of sufficient strength to indicate those discontinuities which are unacceptable, yet must not be so strong that an excess of local particle accumulation masks relevant indications (see Section 14).

4.4 *Types of Magnetic Particles and Their Use*—There are various types of magnetic particles available for use in magnetic particle testing. They are available as dry powders (fluorescent and nonfluorescent) ready for use as supplied (see 8.4), powder concentrates (fluorescent and nonfluorescent) for dispersion in water or suspending in light petroleum distillates (see 8.5), magnetic slurries/paints (see 8.5.7), and magnetic polymer dispersions (see 8.5.8).

4.5 *Evaluation of Indications*—When the material to be examined has been properly magnetized, the magnetic particles have been properly applied, and the excess particles properly removed, there will be accumulations of magnetic particles remaining at the points of flux leakage. These accumulations show the distortion of the magnetic field and are called indications. Without disturbing the particles, the indications must be examined, classified, compared with the acceptance standards, and a decision made concerning the disposition of the material that contains the indication.

4.6 *Typical Magnetic Particle Indications:*

4.6.1 *Surface Discontinuities*—Surface discontinuities, with few exceptions, produce sharp, distinct patterns (see Annex A1).

4.6.2 *Near-surface discontinuities*—Near-surface discontinuities produce less distinct indications than those open to the

surface. The patterns tend to be broad, rather than sharp, and the particles are less tightly held (see Annex A1).

5. Significance and Use

5.1 The magnetic particle method of nondestructive testing indicates the presence of surface and near-surface discontinuities in materials that can be magnetized (ferromagnetic). This method can be used for production examination of parts/components or structures and for field applications where portability of equipment and accessibility to the area to be examined are factors. The ability of the method to find small discontinuities can be enhanced by using fluorescent particles suspended in a suitable vehicle and by introducing a magnetic field of the proper strength whose orientation is as close as possible to 90° to the direction of the suspected discontinuity (see 4.3.2). A smoother surface or a pulsed current improves mobility of the magnetic particles under the influence of the magnetic field to collect on the surface where magnetic flux leakage occurs.

6. Equipment

6.1 *Types*—There are a number of types of equipment available for magnetizing ferromagnetic parts and components. With the exception of a permanent magnet, all equipment requires a power source capable of delivering the required current levels to produce the magnetic field. The current used dictates the sizes of cables and the capability of relays, switching contacts, meters and rectifier if the power source is alternating current.

6.2 *Portability*—Portability, which includes the ability to hand carry the equipment, can be obtained from yokes, portable coils with power supplies, and capacitor discharge power supplies with cables. Generally, portable coils provide high magnetizing forces by using higher numbers of turns to compensate for their lower current flow. Capacitor discharge units use high current storage capacity and provide these high current levels for only a very short duration.

6.3 *Yokes*—Yokes are usually C-shaped electromagnets which induce a magnetic field between the poles (legs) and are used for local magnetization (Fig. 1). Many portable yokes



FIG. 1 Yoke Method of Part Magnetization

have articulated legs (poles) that allow the legs to be adjusted to contact irregular surfaces or two surfaces that join at an angle.

6.3.1 *Permanent Magnets*—Permanent magnets are available but their use may be restricted for many applications. This restriction may be due to application impracticality, or due to the specifications governing the examination. Permanent magnets can lose their magnetic field generating capacity by being partially demagnetized by a stronger flux field, being damaged, or dropped. In addition, the particle mobility created by AC current or HW current pulsations produced by electromagnetic yokes are not present. Particles, steel filings, chips, and scale clinging to the poles can create a housekeeping problem.

6.4 *Prods*—Prods are used for local magnetizations, see Fig. 2. The prod tips that contact the piece should be aluminum, copper braid, or copper pads rather than solid copper. With solid copper tips, accidental arcing during prod placement or removal can cause copper penetration into the surface which may result in metallurgical damage (softening, hardening, cracking, etc.). Open-circuit voltages should not exceed 25 V.

6.4.1 *Remote Control Switch*—A remote-control switch, which may be built into the prod handles, should be provided to permit the current to be turned on after the prods have been properly placed and to turn it off before the prods are removed in order to prevent arcing (arc burns).

6.5 *Bench Unit*—A typical bench type unit is shown in Fig. 3. The unit normally is furnished with a head/tailstock combination along with a fixed coil (see Fig. 4).

6.6 *Black Light*—The black light must be capable of developing a peak wavelength output at or near 365 nm with an intensity at the examination surface that satisfies 7.1.2. Suitable filters are used to remove the extraneous visible light and any harmful UV radiation emitted by the black light bulb. Some high intensity black light bulbs may emit unacceptable amounts of blue light that may cause indications to become invisible due to the increase in surface background. Refer to E2297 for more detail. When using a mercury vapor bulb a change in line voltage greater than $\pm 10\%$ can cause a change in black light output with consequent inconsistent performance. A constant voltage transformer may be used where there is evidence of voltage changes greater than 10%.

6.7 *Equipment Verification*—See Section 20.

7. Examination Area

7.1 *Light Intensity for Examination*—Magnetic indications found using nonfluorescent particles are examined under visible light. Indications found using fluorescent particles must be examined under black (ultraviolet) light. This requires a darkened area with accompanying control of the visible light intensity.

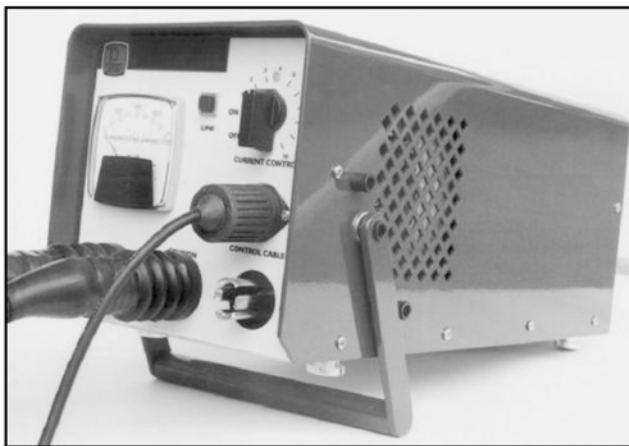

Typical portable power pack for prods



Typical Single Prod Set



Typical Double Prod Set

FIG. 2



FIG. 3 Bench Unit

7.1.1 Visible Light Intensity—The intensity of the visible light at the surface of the part/work piece undergoing nonfluorescent particle examination is recommended to be a minimum of 100 foot candles (1076 lux). The intensity of ambient visible light in the darkened area where fluorescent magnetic particle testing is performed is recommended to not exceed 2 foot candles (21.5 lux).

7.1.1.1 Field Examinations—For some field examinations using nonfluorescent particles, visible light intensities as low as 50 foot candles (538 lux) may be used when agreed on by the contracting agency.

7.1.2 Black (Ultraviolet) Light:

7.1.2.1 Black Light Intensity—The black light intensity at the examination surface is recommended to not be less than 1000 $\mu\text{W}/\text{cm}^2$ when measured with a suitable black light meter.

7.1.2.2 Black Light Warm-up—When using a mercury vapor bulb, allow the black light to warm up for a minimum of five minutes prior to its use or measurement of the intensity of the ultraviolet light emitted.

7.1.3 Dark Area Eye Adaptation—The generally accepted practice is that an inspector be in the darkened area at least one (1) minute so that his/her eyes will adapt to dark viewing prior to examining parts under UV illumination. (**Warning**—Photochromic or permanently tinted lenses should not be worn during examination.)

7.2 Housekeeping—The examination area should be kept free of interfering debris. If fluorescent materials are involved, the area should also be kept free of fluorescent objects not related to the part/piece being examined.

8. Magnetic Particle Materials

8.1 Magnetic Particle Properties:

8.1.1 Dry Particle Properties—AMS 3040 describes the generally accepted properties of dry method particles.

8.1.2 Wet Particle Properties—The following documents describe the generally accepted properties of wet method particles in their various forms:

AMS 3041 Magnetic Particles, Non-fluorescent, Wet Method, Oil Vehicle, Ready to Use

AMS 3042 Magnetic Particles, Non-fluorescent, Wet Method, Dry Powder

AMS 3043 Magnetic Particles, Non-fluorescent, Oil Vehicle, Aerosol Packaged

AMS 3044 Magnetic Particles, Fluorescent, Wet Method, Dry Powder

AMS 3045 Magnetic Particles, Non-fluorescent, Wet Method, Oil Vehicle, Ready to Use

AMS 3046 Magnetic Particles, Non-fluorescent, Wet Method, Oil Vehicle, Aerosol Packaged

8.1.3 Suspension Vehicle—The suspension vehicle for wet-method examination may be either a light oil distillate fluid (refer to AMS 2641 or A-A-52930) or a conditioned water vehicle (refer to AS 4792).

8.2 Particle Types—The particles used in either dry or wet magnetic particle testing techniques are basically finely divided ferromagnetic materials which have been treated to impart color (fluorescent and nonfluorescent) in order to make them highly visible (contrasting) against the background of the surface being examined. The particles are designed for use either as a free flowing dry powder or for suspension at a given concentration in a suitable liquid medium.

8.3 Particle Characteristics—The magnetic particles must have high permeability to allow ease of magnetizing and attraction to the site of the flux leakage and low retentivity so they will not be attracted (magnetic agglomeration) to each other. Control of particle size and shape is required to obtain consistent results. The particles should be nontoxic, free from rust, grease, paint, dirt, and other deleterious materials that might interfere with their use; see 20.5 and 20.6. Both dry and wet particles are considered safe when used in accordance with the manufacturer's instructions. They generally afford a very low hazard potential with regard to flammability and toxicity.

8.4 Dry Particles—Dry magnetic powders are designed to be used as supplied and are applied by spraying or dusting directly onto the surface of the part being examined. They are generally used on an expendable basis because of the requirement to maintain particle size and control possible contamination. Reuse is not a normal practice. Dry powders may also be used under extreme environmental conditions. They are not affected by cold; therefore examination can be carried out at temperatures that would thicken or freeze wet baths. They are also heat resistant; some powders may be usable at temperatures up to 600°F (315°C). Some colored, organic coatings applied to dry particles to improve contrast lose their color at temperatures this high, making the contrast less effective. Fluorescent dry particles cannot be used at this high a temperature; the manufacturer should be contacted for the temperature limitations.

8.4.1 Advantages—The dry magnetic particle technique is generally superior to the wet technique for detection of near-surface discontinuities on parts with a gross indication size. Refer to 8.5.1: (a) for large objects when using portable equipment for local magnetization; (b) superior particle mobility is obtained for relatively deep-seated flaws using half-wave rectified current as the magnetizing source; (c) ease of removal.

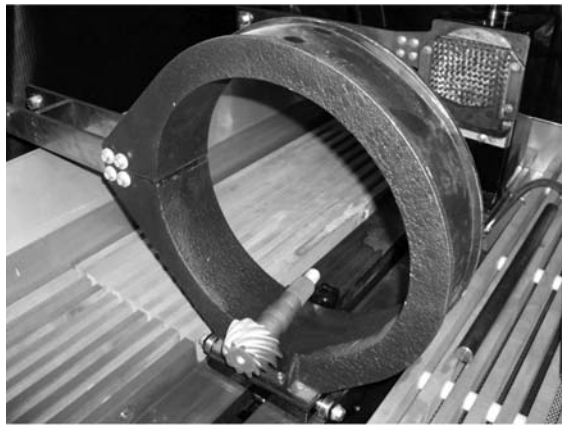

Pinion gear in coil

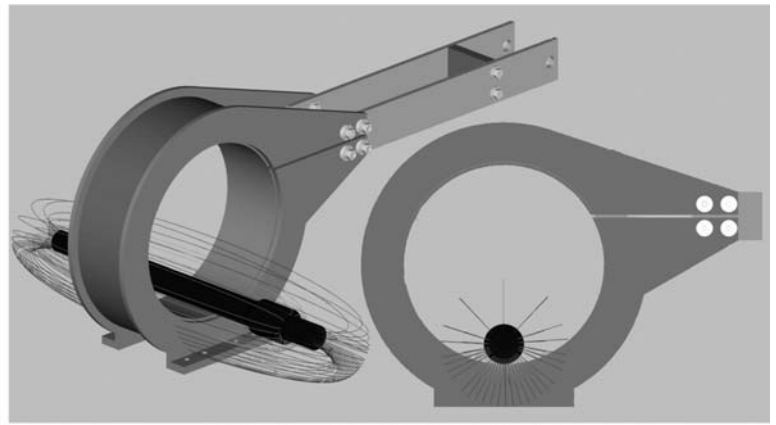

Conception showing flux distribution with part in the bottom of the coil

FIG. 4 Bench Fixed Coil and Field Distribution

8.4.2 *Disadvantages*—The dry magnetic particle technique; (a) cannot be used in confined areas without proper safety breathing apparatus; (b) can be difficult to use in overhead magnetizing positions; (c) does not always leave evidence of complete coverage of part surface as with the wet technique; (d) is likely to have lower production rates than the wet technique; and (e) is difficult to adapt to any type of automatic system.

8.4.3 *Nonfluorescent Colors*—Although dry magnetic particle powder can be almost any color, the most frequently employed colors are light gray, black, red, or yellow. The choice is generally based on maximum contrast with the surface to be examined. The examination is done under visible light.

8.4.4 *Fluorescent*—Fluorescent dry magnetic particles are also available, but are not in general use primarily because of their higher cost and use limitations. They require a black light source and a darkened work area. These requirements are not often available in the field-type locations where dry magnetic particle examinations are especially suitable.

8.4.5 *Dual Colors*—Dual-colored particles are available that are readily detectable in visible light and also display fluorescence when viewed under ultra-violet light or a combination visible and ultra-violet light. Use in accordance with the manufacturer's recommendations.

8.5 *Wet Particle Systems*—Wet magnetic particles are designed to be suspended in a vehicle such as water or light petroleum distillate at a given concentration for application to the examination surface by flowing, spraying, or pouring. They are available in both fluorescent and nonfluorescent concentrates. In some cases the particles are premixed with the suspending vehicle by the supplier, but usually the particles are supplied as a dry concentrate or paste concentrate which is mixed with the distillate or water by the user. The suspensions are normally used in wet horizontal magnetic particle equipment in which the suspension is retained in a reservoir and recirculated for continuous use. The suspension may also be used on an expendable basis dispensed from an aerosol or other suitable dispensers.

8.5.1 *Primary Use*—Because the particles used are smaller, wet method techniques are generally used to locate smaller

discontinuities than the dry method is used for. The liquid vehicles used may not perform satisfactorily when their viscosity exceeds 5cSt (5 mm²/s) at the operating temperature. If the suspension vehicle is a hydrocarbon, its flash point limits the top temperature of usage. Mixing equipment for bulk reservoirs or manual agitation for portable dispensers is usually required to keep wet method particles uniformly in suspension.

8.5.2 *Where Used*—The wet fluorescent method usually is performed indoors or in areas where shelter and ambient light level can be controlled and where proper application equipment is available.

8.5.3 *Color*—The color chosen for any given examination should be one that best contrasts with the test surface. Because contrast is invariably higher with fluorescent materials, these are utilized in most wet process examinations. Fluorescent wet method particles normally glow a bright yellow-green when viewed under black light, although other colors are available. Non-fluorescent particles are usually black or reddish brown, although other colors are available. Dual-colored particles are available that are readily detectable in visible light and also display fluorescence when viewed under ultra-violet light or a combination visible and ultra-violet light. Refer to 8.5.5.

8.5.4 *Suspension Vehicles*—Generally the particles are suspended in a light petroleum (low-viscosity) distillate or conditioned water. (If sulfur or chlorine limits are specified, use Test Methods E165, Annex A2 or A4 to determine their values.

8.5.4.1 *Petroleum Distillates*—Low-viscosity light petroleum distillates vehicles (AMS 2641 Type 1 or equal) are ideal for suspending both fluorescent and nonfluorescent magnetic particles and are commonly employed.

(1) *Advantages*—Two significant advantages for the use of petroleum distillate vehicles are: (a) the magnetic particles are suspended and dispersed in petroleum distillate vehicles without the use of conditioning agents; and (b) the petroleum distillate vehicles provide a measure of corrosion protection to parts and the equipment used.

(2) *Disadvantages*—Principal disadvantages are flammability, fumes, and availability. It is essential, therefore, to select and maintain readily available sources of supply of petroleum distillate vehicles that have as high a flash point as practicable

to avoid possible flammability problems and provide a work area with proper ventilation.

(3) *Characteristics*—Petroleum distillate vehicles to be used in wet magnetic particle testing should possess the following: (a) viscosity should not exceed 3.0 cSt (3 mm²/s) at 100°F (38°C) and not more than 5.0 cSt (5 mm²/s) at the lowest temperature at which the vehicle will be used; when verified in accordance with Test Method **D445**, in order not to impede particle mobility (see **20.7.3**), (b) minimum flash point, when verified in accordance with Test Methods **D93**, should be 200°F (93°C) in order to minimize fire hazards (see **20.7.4**), (c) odorless; not objectionable to user, (d) low inherent fluorescence if used with fluorescent particles; that is, it should not interfere significantly with the fluorescent particle indications (see **20.6.4.1**), and (e) nonreactive; should not degrade suspended particles.

8.5.4.2 *Water Vehicles with Conditioning Agents*—Water may be used as a suspension vehicle for wet magnetic particles provided suitable conditioning agents are added which provide proper wet dispersing, in addition to corrosion protection for the parts being examined and the equipment in use. Plain water does not disperse some types of magnetic particles, does not wet all surfaces, and is corrosive to parts and equipment. On the other hand, conditioned water suspensions of magnetic particles are safer to use since they are nonflammable. The selection and concentration of the conditioning agent should be as recommended by the particle manufacturer. The following are recommended properties for water vehicles containing conditioning agents for use with wet magnetic particle testing:

(1) *Wetting Characteristics*—The vehicle should have good wetting characteristics; that is, wet the surface to be examined, give even, complete coverage without evidence of dewetting the examination surface. The surface tension (coverage) should be observed under both black light and visible light. Smooth examination surfaces require that a greater percentage of wetting agent be added than is required for rough surface. Nonionic wetting agents are recommended (see **20.7.5**).

(2) *Suspension Characteristics*—Impart good dispersability; that is, thoroughly disperse the magnetic particles without evidence of particle agglomeration.

(3) *Foaming*—Minimize foaming; that is, it should not produce excessive foam which would interfere with indication formation or cause particles to form scum with the foam.

(4) *Corrosiveness*—It should not corrode parts to be examined or the equipment in which it is used.

(5) *Viscosity Limit*—The viscosity of the conditioned water should not exceed a maximum viscosity of 3 cSt (3 mm²/s) at 100°F (38°C) (see **20.7.3**).

(6) *Fluorescence*—The conditioned water should not produce excessive fluorescence if intended for use with fluorescent particles.

(7) *Nonreactiveness*—The conditioned water should not cause deterioration of the suspended magnetic particles.

(8) *Water pH*—The pH of the conditioned water should not be less than 7.0 or exceed 10.5.

(9) *Odor*—The conditioned water should be essentially odorless.

8.5.5 *Concentration of Wet Magnetic Particle Suspension*—The initial bath concentration of suspended magnetic particles should be as specified or as recommended by the manufacturer and should be checked by settling volume measurements and maintained at the specified concentration on a daily basis. If the concentration is not maintained properly, examination results can vary greatly. The concentration of dual-colored particles in the wet-method bath suspension may be adjusted to best perform in the desired lighting environment. Higher particle concentration is recommended for visible light areas and lower particle concentration is recommended for ultraviolet light areas. Use in accordance with the particle manufacturer's recommendations.

8.5.6 *Application of Wet Magnetic Particles* (see **15.2**).

8.5.7 *Magnetic Slurry/Paint Systems*—Another type of examination vehicle is the magnetic slurry/paint type consisting of a heavy oil in which flake-like particles are suspended. The material is normally applied by brush before the part is magnetized. Because of the high viscosity, the material does not rapidly run off surfaces, facilitating the examination of vertical or overhead surfaces. The vehicles may be combustible, but the fire hazard is very low. Other hazards are very similar to those of the oil and water vehicles previously described.

8.5.8 *Polymer-Based Systems*—The vehicle used in the magnetic polymer is basically a liquid polymer which disperses the magnetic particles and which cures to an elastic solid in a given period of time, forming fixed indications. Viscosity limits of standard wet technique vehicles do not apply. Care should be exercised in handling these polymer materials. Use in accordance with manufacturer's instructions and precautions. This technique is particularly applicable to examination areas of limited visual accessibility, such as bolt holes.

9. Part Preparation

9.1 *General*—The surface of the part to be examined should be essentially clean, dry, and free of contaminants such as dirt, oil, grease, loose rust, loose mill sand, loose mill scale, lint, thick paint, welding flux/slag, and weld splatter that might restrict particle movement. See **15.1.2** about applying dry particles to a damp/wet surface. When examining a local area, such as a weld, the areas adjacent to the surface to be examined, as agreed by the contracting parties, must also be cleaned to the extent necessary to permit detection of indications.

9.1.1 *Nonconductive Coatings*—Thin nonconductive coatings, such as paint in the order of 0.02 to 0.05 mm (1 or 2 mil) will not normally interfere with the formation of indications, but they must be removed at all points where electrical contact is to be made for direct magnetization. Indirect magnetization does not require electrical contact with the part/piece. See Section **12.2**. If a nonconducting coating/plating is left on the area to be examined that has a thickness greater than 0.05 mm (2 mil), it must be demonstrated that unacceptable discontinuities can be detected through the maximum thickness applied.

9.1.2 *Conductive Coatings*—A conductive coating (such as chrome plating and heavy mill scale on wrought products resulting from hot forming operations) can mask discontinuities. As with nonconductive coatings, it must be demonstrated that the unacceptable discontinuities can be detected through the coating.

9.1.3 *Residual Magnetic Fields*—If the part/piece holds a residual magnetic field from a previous magnetization that will interfere with the examination, the part must be demagnetized. See Section 18.

9.2 *Cleaning Examination Surface*—Cleaning of the examination surface may be accomplished by detergents, organic solvents, or mechanical means. As-welded, as-rolled, as-cast, or as-forged surfaces are generally satisfactory, but if the surface is unusually nonuniform, as with burned-in sand, a very rough weld deposit, or scale, interpretation may be difficult because of mechanical entrapment of the magnetic particles. In case of doubt, any questionable area should be recleaned and reexamined (see 9.1).

9.2.1 *Plugging and Masking Small Holes and Openings*—Unless prohibited by the purchaser, small openings and oil holes leading to obscure passages or cavities can be plugged or masked with a suitable nonabrasive material which is readily removed. In the case of engine parts, the material must be soluble in oil. Effective masking must be used to protect components that may be damaged by contact with the particles or particle suspension.

10. Sequence of Operations

10.1 *Sequencing Particle Application and Establishing Magnetic Flux Field*—The sequence of operation in magnetic particle examination applies to the relationship between the timing and application of particles and establishing the magnetizing flux field. Two basic techniques apply, that is, continuous (see 10.1.1 and 10.1.2) and residual (see 10.1.3), both of which are commonly employed in industry.

10.1.1 *Continuous Magnetization*—Continuous magnetization is employed for most applications utilizing either dry or wet particles and will provide higher magnetic field strengths, to aid indication formation better, than residual magnetic fields. The continuous method must be used when performing multidirectional magnetization. The sequence of operation for the dry and the wet continuous magnetization techniques are significantly different and are discussed separately in 10.1.1.1 and 10.1.1.2.

10.1.1.1 *Dry Continuous Magnetization Technique*—Unlike a wet suspension, dry particles lose most of their mobility when they contact the surface of a part. Therefore, it is imperative that the part/area of interest be under the influence of the applied magnetic field while the particles are still airborne and free to be attracted to leakage fields. This dictates that the flow of magnetizing current be initiated prior to the application of dry magnetic particles and terminated after the application of powder has been completed and any excess has been blown off. Magnetizing with HW current and AC current provide additional particle mobility on the surface of the part. Examination with dry particles is usually carried out in

conjunction with prod-type or yoke localized magnetizations, and buildup of indications is observed as the particles are being applied.

10.1.1.2 *Wet Continuous Magnetization Technique*—The wet continuous magnetization technique involves bathing the part with the examination medium to provide an abundant source of suspended particles on the surface of the part and terminating the bath application immediately prior to cutting off of the magnetizing current. The duration of the magnetizing current is typically on the order of 1/2 s for each magnetizing pulse (shot), with two or more shots given to the part.

10.1.1.3 *Polymer or Slurry Continuous Magnetization Technique*—Prolonged or repeated periods of magnetization are often necessary for polymer- or slurry-base suspensions because of slower inherent magnetic particle mobility in the high-viscosity suspension vehicles.

10.1.2 *True Continuous Magnetization Technique*—In this technique, the magnetizing current is sustained throughout both the processing and examination of the part.

10.1.3 *Residual Magnetization Techniques*:

10.1.3.1 *Residual Magnetization*—In this technique, the examination medium is applied after the magnetizing force has been discontinued. It can be used only if the material being examined has relatively high retentivity so the residual leakage field will be of sufficient strength to attract and hold the particles and produce indications. This technique may be advantageous for integration with production or handling requirements or when higher than residual field strengths are not required to achieve satisfactory results. When inducing circular fields and longitudinal fields of long pieces, residual fields are normally sufficient to meet magnetizing requirements consistent with the requirements of Section 14. The residual method has found wide use examining pipe and tubular goods. For magnetization requirements of oilfield tubulars, refer to Appendix XI. Unless demonstrations with typical parts indicate that the residual field has sufficient strength to produce relevant indications of discontinuities (see 20.8) when the field is in proper orientation, the continuous method should be used.

11. Types of Magnetizing Currents

11.1 *Basic Current Types*—The four basic types of current used in magnetic particle testing to establish part magnetization are alternating current (AC), half-wave rectified current (HW), full-wave rectified current (FW), and for a special application, DC.

11.1.1 *Alternating Current (AC)*—Part magnetization with alternating current is preferred for those applications where examination requirements call for the detection of discontinuities, such as fatigue cracks, that are open to the surface to which the magnetizing force is applied. Associated with AC is a “skin effect” that confines the magnetic field at or near to the surface of a part. In contrast, both HW current and FW current produce a magnetic field having penetrating capabilities proportional to the amount of applied current, which should be used when near-surface or inside surface discontinuities are of concern.

11.1.2 *Half-Wave Rectified Current (HW)*—Half-wave current is frequently used in conjunction with wet and dry particles because the current pulses provide more mobility to

the particles. This waveform is used with prods, yokes, mobile and bench units. Half-wave rectified current is used to achieve depth of penetration for detection of typical discontinuities found in weldments, forgings, and ferrous castings. As with AC for magnetization, single-phase current is utilized and the average value measured as “magnetizing current.”

11.1.3 *Full-Wave Rectified Current (FW)*—Full-wave current may utilize single- or three-phase current. Three-phase current has the advantage of lower line amperage draws, whereas single-phase equipment is less expensive. Full-wave rectified current is commonly used when the residual method is to be employed. Because particle movement, either dry or wet is noticeably less, precautions must be taken to ensure that sufficient time is allowed for formation of indications.

11.1.4 *Direct Current (DC)*—A bank of batteries, full-wave rectified AC filtered through capacitors or a DC generator produce direct magnetizing current. They have largely given way to half-wave rectified or full-wave rectified DC except for a few specialized applications, primarily because of broad application advantages when using other types of equipment.

11.1.5 *Capacitor Discharge (CD) Current*—A bank of capacitors are used to store energy and when triggered the energy reaches high amperage with a very short duration (normally less than 25 milliseconds). Because of the short pulse duration the current requirements are affected by the amount of material

to be magnetized as well as the applied amperage. The capacitor discharge technique is widely used to establish a residual magnetic field in tubing, casing, line pipe, and drill pipe. For specific requirements, see [Appendix X1](#).

12. Part Magnetization Techniques

12.1 *Examination Coverage*—All examinations should be conducted with sufficient area overlap to assure the required coverage at the specified sensitivity has been obtained.

12.2 *Direct and Indirect Magnetization*—A part can be magnetized either directly or indirectly. For direct magnetization the magnetizing current is passed directly through the part creating a magnetic field oriented 90 degrees to current flow in the part. With indirect magnetization techniques a magnetic field is induced in the part, which can create a circular/toroidal, longitudinal, or multidirectional magnetic field in the part. The techniques described in 20.8 for verifying that the magnetic fields have the anticipated direction and strength should be employed. This is especially important when using multidirectional techniques to examine complex shapes.

12.3 *Choosing Magnetization Technique*—The choice of direct or indirect magnetization will depend on such factors as size, configuration, or ease of processing. [Table 1](#) compares the advantages and limitations of the various methods of part magnetization.

TABLE 1 Advantages and Limitations of the Various Ways of Magnetizing a Part

Magnetizing Technique and Material Form	Advantages	Limitations
I. Direct Contact Part Magnetization (see 12.3.1)		
Head/Tailstock Contact Solid, relatively small parts (castings, forgings, machined pieces) that can be processed on a horizontal wet unit	<ol style="list-style-type: none"> 1. Fast, easy technique. 2. Circular magnetic field surrounds current path. 3. Good sensitivity to surface and near-surface discontinuities. 4. Simple as well as relatively complex parts can usually be easily processed with one or more shots. 5. Complete magnetic path is conducive to maximizing residual characteristics of material. 	<ol style="list-style-type: none"> 1. Possibility of arc burns if poor contact conditions exist. 2. Long parts should be examined in sections to facilitate bath application without resorting to an overly long current shot.
Large castings and forgings	<ol style="list-style-type: none"> 1. Large surface areas can be processed and examined in relatively short time. 	<ol style="list-style-type: none"> 1. High amperage requirements (16 000 to 20 000 A) dictate costly DC power supply.
Cylindrical parts such as tubing, pipe, hollow shafts, etc.	<ol style="list-style-type: none"> 1. Entire length can be circularly magnetized by contacting, end to end. 	<ol style="list-style-type: none"> 1. Effective field limited to outside surface and cannot be used for inside diameter examination. 2. Ends must be conductive to electrical contacts and capable of carrying required current without excessive heat. Cannot be used on oilfield tubulars because of possibility of arc burns.
Long solid parts such as billets, bars, shafts, etc.	<ol style="list-style-type: none"> 1. Entire length can be circularly magnetized by contacting, end to end. 2. Current requirements are independent of length. 3. No end loss. 	<ol style="list-style-type: none"> 1. Output voltage requirements increase as the part length increases, due to greater value of the impedance and/or resistance as the cables and part length grows. 2. Ends must be conductive to electrical contact and capable of carrying required current without excessive heat.
Prods: Welds	<ol style="list-style-type: none"> 1. Circular field can be selectively directed to weld area by prod placement. 2. In conjunction with half-wave rectified alternating current and dry powder, provides excellent sensitivity to subsurface discontinuities as well as surface type. 3. Flexible, in that prods, cables, and power packs can be brought to examination site. 	<ol style="list-style-type: none"> 1. Only small area can be examined at one time. 2. Arc burns due to poor contact. 3. Surface must be dry when dry powder is being used.

TABLE 1 *Continued*

Magnetizing Technique and Material Form	Advantages	Limitations
Large castings or forgings	<ol style="list-style-type: none"> Entire surface area can be examined in small increments using nominal current values. Circular field can be concentrated in specific areas that historically are prone to discontinuities. Equipment can be brought to the location of parts that are difficult to move. In conjunction with half-wave rectified alternating current and dry powder, provides excellent sensitivity to near surface subsurface type discontinuities that are difficult to locate by other methods. 	<ol style="list-style-type: none"> Prod spacing must be in accordance with the magnetizing current level. Coverage of large surface area require a multiplicity of shots that can be very time-consuming. Possibility of arc burns due to poor contact. Surface should be dry when dry powder is being used. Large power packs (over 6000A) often require a large capacity voltage source to operate. When using HW current or FW current on retentive materials, it is often necessary that the power pack be equipped with a reversing DC demagnetizing option.
II. Indirect Part Magnetization (see 12.3.2)		
Central Conductor Miscellaneous parts having holes through which a conductor can be placed such as: Bearing race Hollow cylinder Gear Large nut	<ol style="list-style-type: none"> When used properly, no electrical contact is made with the part and possibility of arc burns eliminated. Circumferentially directed magnetic field is generated in all surfaces, surrounding the conductor (inside diameter, faces, etc.). Ideal for those cases where the residual method is applicable. Light weight parts can be supported by the central conductor. Smaller central conductor and multiple coil wraps may be used to reduce current requirements. 	<ol style="list-style-type: none"> Size of conductor must be ample to carry required current. Larger diameters require repeated magnetization with conductor against inside diameter and rotation of part between processes. Where continuous magnetization technique is being employed, examination is required after each magnetization step.
Large clevis Pipe coupling, casing/tubing Tubular type parts such as: Pipe/Casting Tubing Hollow shaft	<ol style="list-style-type: none"> When used properly, no electrical contact is made with the part and possibility of arc burns eliminated. Inside diameter as well as outside diameter examination. Entire length of part circularly magnetized. 	<ol style="list-style-type: none"> Outside surface sensitivity may be somewhat less than that obtained on the inside surface for large diameter and extremely heavy wall sections.
Large valve bodies and similar parts	<ol style="list-style-type: none"> Provides good sensitivity for detection of discontinuities located on internal surfaces. 	<ol style="list-style-type: none"> Outside surface sensitivity may be somewhat less than that obtained on the inside diameter for heavy wall sections.
Coil/Cable Wrap Miscellaneous medium-sized parts where the length predominates such as a crankshaft	<ol style="list-style-type: none"> All generally longitudinal surfaces are longitudinally magnetized to effectively locate transverse discontinuities. 	<ol style="list-style-type: none"> Length may dictate multiple shot as coil is repositioned. Longitudinal magnetization of complex parts with upsets such as crankshafts will lead to dead spots where the magnetic field is cancelled out. Care must be taken to assure magnetization of all areas in perpendicular directions.
Large castings, forgings, or shafting	<ol style="list-style-type: none"> Longitudinal field easily attained by means of cable wrapping. 	<ol style="list-style-type: none"> Multiple magnetization may be required due to configuration of part.
Miscellaneous small parts	<ol style="list-style-type: none"> Easy and fast, especially where residual magnetization is applicable. No electrical contact. Relatively complex parts can usually be processed with same ease as those with simple cross section. 	<ol style="list-style-type: none"> L/D (length/diameter) ratio important consideration in determining adequacy of ampere-turns. Effective L/D ratio can be altered by utilizing pieces of similar cross-sectional area. Use smaller coil for more intense field. Sensitivity diminishes at ends of part due to general leakage field pattern. Quick break desirable to minimize end effect on short parts with low L/D ratio.
Induced Current Fixtures Examination of ring-shaped part for circumferential-type discontinuities.	<ol style="list-style-type: none"> No electrical contact. All surface of part subjected to toroidal-type magnetic field. Single process for 100 % coverage. Can be automated. 	<ol style="list-style-type: none"> Laminated core required through ring. Type of magnetizing current must be compatible with method. Other conductors encircling field must be avoided. Large diameters require special consideration.
Ball examination	<ol style="list-style-type: none"> No electrical contact. 100 % coverage for discontinuities in any direction with three-step process and proper orientation between steps. 	<ol style="list-style-type: none"> For small-diameter balls, limited to residual magnetization.

TABLE 1 Continued

Magnetizing Technique and Material Form	Advantages	Limitations
Disks and gears	<ol style="list-style-type: none"> 1. No electrical contact. 2. Good sensitivity at or near periphery or rim. 3. Sensitivity in various areas can be varied by core or pole-piece selection. 	<ol style="list-style-type: none"> 1. 100 % coverage may require two-step process with core or pole-piece variation, or both. 2. Type of magnetizing current must be compatible with part geometry.
Yokes: Examination of large surface areas for surface-type discontinuities.	<ol style="list-style-type: none"> 1. No electrical contact. 2. Highly portable. 3. Can locate discontinuities in any direction with proper orientation. 	<ol style="list-style-type: none"> 1. Time consuming. 2. Must be systematically repositioned in view of random discontinuity orientation.
Miscellaneous parts requiring examination of localized areas.	<ol style="list-style-type: none"> 1. No electrical contact. 2. Good sensitivity to direct surface discontinuities. 3. Highly portable. 4. Wet or dry technique. 5. Alternating-current type can also serve as demagnetizer in some instances. 	<ol style="list-style-type: none"> 1. Must be properly positioned relative to orientation of discontinuities. 2. Relatively good contact must be established between part and poles. 3. Complex part geometry may cause difficulty. 4. Poor sensitivity to subsurface-type discontinuities except in isolated areas.

12.3.1 *Direct Contact Magnetization*—For direct magnetization, physical contact must be made between the ferromagnetic part and the current carrying electrodes connected to the power source. Both localized area magnetization and overall part magnetization are direct contact means of part magnetization, and can be achieved through the use of prods, head and tailstock, clamps, and magnetic leeches.

12.3.2 *Localized Area Magnetization:*

12.3.2.1 *Prod Technique*—The prod electrodes are first pressed firmly against the part under examination (see Fig. 2). The magnetizing current is then passed through the prods and into the area of the part in contact with the prods. This establishes a circular magnetic field in the part around and between each prod electrode, sufficient to carry out a local magnetic particle examination (see Fig. 2). (**Warning**—Extreme care should be taken to maintain clean prod tips, to minimize heating at the point of contact and to prevent arc burns and local overheating on the surface being examined since these may cause adverse effects on material properties. Arc burns may cause metallurgical damage; if the tips are solid copper, copper penetration into the part may occur. Prods should not be used on machined surfaces or on aerospace component parts.)

(1) Unrectified AC limits the prod technique to the detection of surface discontinuities. Half-wave rectified AC is most desirable since it will detect both surface and near-surface discontinuities. The prod technique generally utilizes dry magnetic particle materials due to better particle mobility. Wet magnetic particles are not generally used with the prod technique because of potential electrical and flammability hazards.

(2) Proper prod examination requires a second placement with the prods rotated approximately 90° from the first placement to assure that all existing discontinuities are revealed. Depending on the surface coverage requirements,

overlap between successive prod placements may be necessary. On large surfaces, it is good practice to layout a grid for prod/yoke placement.

12.3.2.2 *Manual Clamp/Magnetic Leech Technique*—Local areas of complex components may be magnetized by electrical contacts manually clamped or attached with magnetic leeches to the part (Fig. 5). As with prods, sufficient overlap may be necessary if examination of the contact location is required.

12.3.2.3 *Overall Magnetization:*

(1) *Head and Tailstock Contact*—Parts may be clamped between two electrodes (such as a head and tailstock of



FIG. 5 Direct Contact Magnetization through Magnetic Leech Clamp of Part

horizontal wet magnetic particle equipment) and the magnetizing current applied directly through the part (Fig. 6). The size and shape of the part will determine whether both field directions can be obtained with such equipment.

(2) *Clamps*—The magnetizing current may be applied to the part under examination by clamping (Fig. 7) the current carrying electrodes to the part, producing a circular magnetic field.

(3) *Multidirectional Magnetization Technique*—With suitable circuitry, it is possible to produce a multidirectional (oscillating) field in a part by selectively switching the magnetic field within the part between electrode contacts/clamps positioned approximately 90° apart or by using a combination of switched direct and indirect methods, such as contact and coil. This permits building up indications in all possible directions and may be considered the equivalent of magnetizing in two or more directions (Fig. 8). On some complex shapes as many as 16 to 20 steps may be required with conventional equipment. With multidirectional magnetization, it is usually possible to reduce the magnetizing steps required by more than half. In many instances, the number of steps may be reduced to one. It is essential that the wet continuous method, be used and that the magnetic field direction and relative intensity be determined by AS 5371 shims as described in Appendix X2 or with an identical part with discontinuities in all areas of interest.

12.3.3 *Indirect Magnetization*—Indirect part magnetization involves the use of a preformed coil, cable wrap, yoke, or a central conductor to induce a magnetic field. Coil, cable wrap, and yoke magnetization are referred to as longitudinal magnetization in the part (see 13.4).

12.3.3.1 *Coil and Cable Magnetization*—When coil (Fig. 4) or cable wrap (Fig. 9) techniques are used, the magnetizing force is proportional to ampere turns (see X3.2.2.1).

12.3.3.2 *Central Conductor, Induced Current Magnetization*—Indirect circular magnetization of hollow pieces/parts can be performed by passing the magnetizing current through a central conductor (Fig. 10(a) and Fig. 10(b)) or cable used as a central conductor or through an induced current fixture (Fig. 8(A)). Central conductors may be solid or



FIG. 7 Spring Loaded Contact Clamp

hollow and are ideally made from non-ferrous material. Ferrous central conductors will function as well, but will generate substantial heat due to magnetic domain movement and a reduced magnetic field outside the conductor when compared to a non-ferrous conductor. Additionally, when using ferromagnetic conductors, the inspector must be made aware of the possibility of magnetic writing. When using a bench-type unit, the distance along the part circumference, which may be effectively examined should be taken as approximately four times the diameter of the central conductor, as illustrated in Fig. 10 (b). The entire circumference should be examined by rotating the part on the conductor, allowing for approximately a 10 % magnetic field overlap. Central conductors are widely used in magnetic particle examination to provide:

(1) A circular field on both the inside surface and outside surface of tubular pieces that cannot be duplicated by the direct current technique.

(2) A non-contact means of part magnetization virtually eliminating the possibility of arc burning the material, as can be the case with current flow through contacts, such as prods or clamps.

(3) Substantial processing advantages over direct contact techniques on ring-shaped parts.

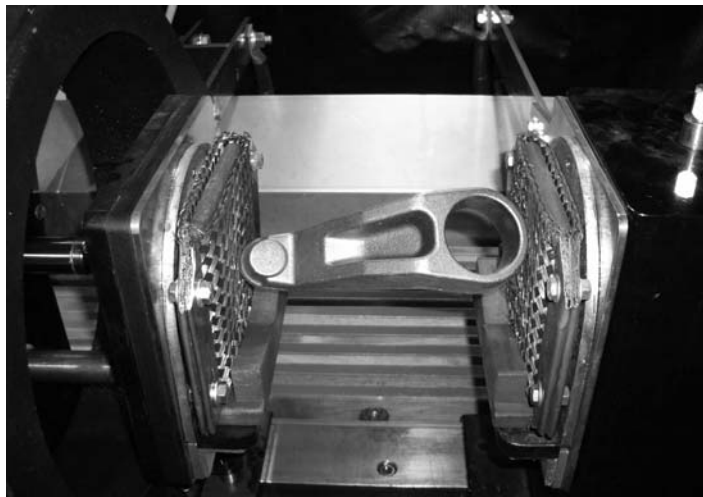

FIG. 6 Direct Contact Shot

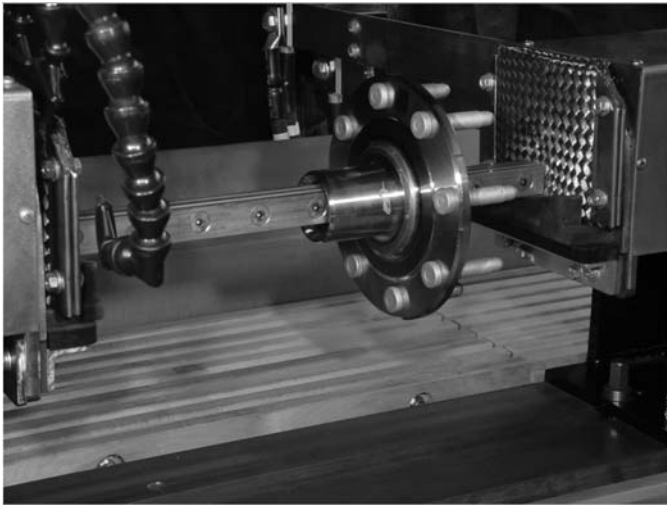

Figure A - Typical 2-vector multidirectional wet horizontal using laminated core



Figure B - Typical 2-vector multidirectional wet horizontal

FIG. 8 Multidirectional Magnetic Particle Units



FIG. 9 Cable Wrap Magnetization

indications may occur in various or unknown directions in a part, each part must be magnetized in at least two directions approximately at right angles to each other as noted in 4.3.2. On some parts circular magnetization may be used in two or more directions, while on others both circular and longitudinal magnetization are used to achieve the same result. For purposes of demagnetization verification, circular magnetism normally precedes longitudinal magnetization. A multidirectional field can also be employed to achieve part magnetization in more than one direction.

13.2 *Circular Magnetization*—Circular magnetization (Fig. 11) is the term used when electric current is passed through a part, or by use of a central conductor (see 12.3.3.2) through a central opening in the part, inducing a magnetic field at right angles to the current flow. Circular fields normally produce strong residual fields, but are not measurable because the flux is contained within the part.

13.3 *Transverse Magnetization*—Transverse magnetization is the term used when the magnetic field is established across the part and the lines of flux complete their loop outside the part. Placing a yoke across a bar normal to the bar axis would produce a transverse field.

13.4 *Toroidal Magnetization*—When magnetizing a part with a toroidal shape, such as a solid wheel or the disk with a center opening, an induced field that is radial to the disk is most useful for the detection of discontinuities in a circumferential direction. In such applications this field may be more effective than multiple shots across the periphery, but requires special equipment.

13.5 *Longitudinal Magnetization*—Longitudinal magnetization (Fig. 12) is the term used when a magnetic field is generated by an electric current passing through a multiturn, which encloses the part or section of the part to be examined.

13.6 *Multidirectional Magnetization*—Multidirectional magnetization may be used to fulfill the requirement for magnetization in two directions if it is demonstrated that it is effective in all areas of interest. Examine parts in accordance with 20.8.2 or shims manufactured to the requirements of

(4) In general it is not important for the central conductor to be centered because the flux lines follow the path of least resistance through the ferromagnetic material. On large diameter materials the central conductor should be within 6 in. of the center. The resulting field is concentric relative to the axis of the piece and is maximum at the inside surface.

12.3.3.3 *Yoke Magnetization*—A magnetic field can be induced into a part by means of an electromagnet (see Fig. 1), where the part or a portion thereof becomes the magnetic path between the poles (acts as a keeper) and discontinuities preferentially transverse to the alignment of the pole pieces are indicated. Most yokes are energized by an input of AC and produce a magnetizing field of AC, half-wave DC, or full-wave DC. A permanent magnet can also introduce a magnetic field in the part, but its use is restricted (see 6.3.1).

13. Direction of Magnetic Fields

13.1 *Discontinuity Orientation vs. Magnetic Field Direction*—Since indications are not normally obtained when discontinuities are parallel to the magnetic field, and since

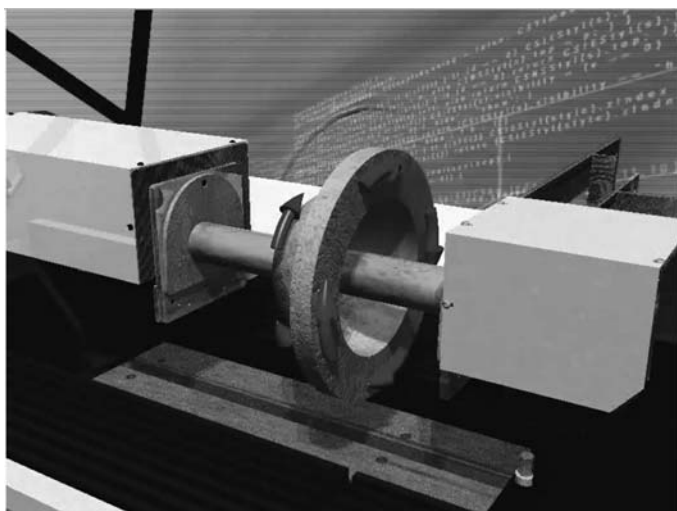

Figure A

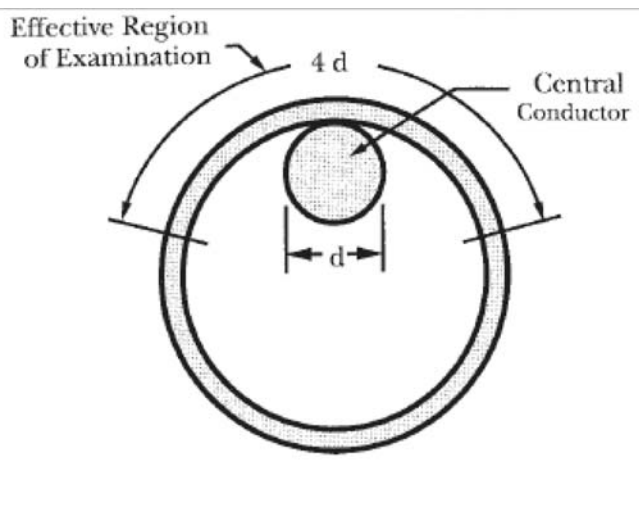

Figure B

FIG. 10 Central Bar Conductors



FIG. 11 Circular Magnetism

AS 5371, or as otherwise approved by the Level 3 and the Cognizant Engineering Organization, may be used to verify field direction, strength, and balance in multidirectional magnetization. Balance of the field intensity is critical. The field intensity should be balanced in all directions. The particle application must be timed so that the magnetization levels reach full value in all directions, while the particles are mobile on the surface under examination.

13.6.1 When actual parts with known defects are used, the number and orientation(s) of the defects (for example, axial, longitudinal, circumferential, etc.) should be noted. The magnetic field intensity can be considered as being properly balanced when all noted defects can be readily identified with particle indications.

13.7 Flexible Laminated Strips for Magnetic Particle Testing

13.7.1 Flexible laminated strips as described in Annex A2 of E1444 may be used to ensure proper field direction during magnetic particle examination. The longitudinal axis of the strip should be placed perpendicular to the direction of the magnetic field of interest in order to generate the strongest

particle indications on the strip. Flexible laminated strips may only be used as a tool to demonstrate the direction of the external magnetic field.

14. Magnetic Field Strength

14.1 *Magnetizing Field Strengths*—To produce interpretable indications, the magnetic field in the part must have sufficient strength and proper orientation. For the indications to be consistent, this field strength must be controlled within reasonable limits, usually $\pm 25\%$ on single vector equipment and when using multi-directional equipment, the field strength must be controlled much closer, often within $\pm 5\%$. Factors that affect the strength of the field are the size, shape, section thickness, material of the part/piece, and the technique of magnetization. Since these factors vary widely, it is difficult to establish rigid rules for magnetic field strengths for every conceivable configuration.

14.2 *Establishing Field Strengths*—Sufficient magnetic field strength can be established by:

14.2.1 *Known Discontinuities*—Experiments with similar/identical parts having known discontinuities in all areas of interest.

14.2.2 *Artificial Discontinuities*—Verification of indications derived from AS 5371 shims (see Appendix X2) taped or glued defect side in contact with the part under examination is an effective means of verifying field strength when using the continuous method.

14.2.3 *Hall-effect Meter Tangential Field Strengths*—A minimum tangential applied field strength of 30 G (2.4 kAM^{-1}) should be adequate when using single vector equipment. Stronger field strengths are allowed, but it must not be so strong that it causes the masking of relevant indications by nonrelevant accumulations of magnetic particles. Due to the complex number of variables, the use of Gaussmeters should not be the sole source of determining an acceptable field on multi-directional techniques.

14.2.3.1 *Circular Magnetism Hall-effect Meter Measurement*—On a part with consistent diameter or thickness, the transverse probe may be placed anywhere along the

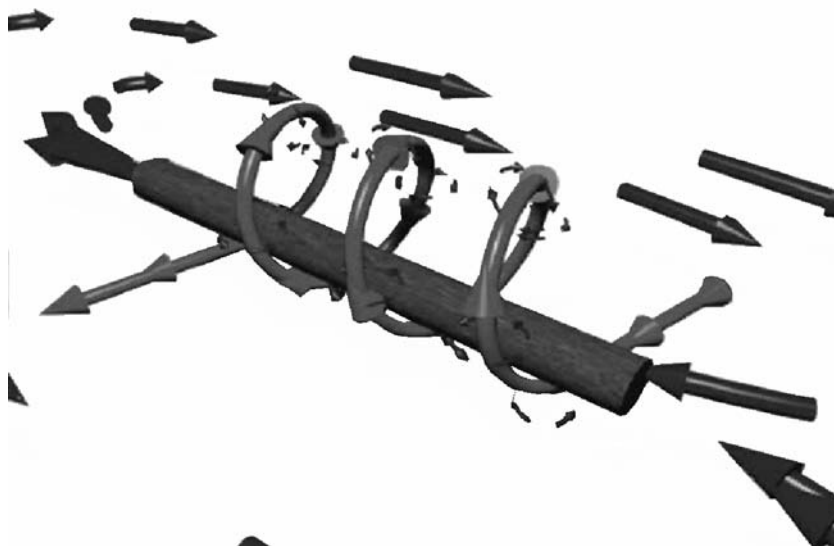

FIG. 12 Longitudinal Magnetism

length of the part as the tangential circular field is consistent across the length. The transverse probe should be positioned upright such that the circular field is normal to the major dimension of the Hall-effect sensor and within 5° of perpendicularity to the part. More than one measurement should be taken to ensure consistent readings. On parts with more than one diameter/thickness, multiple measurements should be taken to ensure a minimum measurement of 30 gauss on all areas to be examined. Measurement is made of the applied field, that is, during the magnetizing shot, not the residual flux field.

14.2.3.2 Longitudinal Magnetism Hall-effect Meter Measurement—On a part with consistent diameter or thickness, the probe may be placed anywhere along the length of the part, except near the poles as the tangential longitudinal field is consistent across the length, except at the poles. Measurement near the poles will yield a skewed reading due to detection of the normal flux field at each pole. Also, measurement near any geometry change that would produce a non-relevant flux leakage should be avoided. The probe should be positioned within 5° of perpendicularity to the part and such that the longitudinal field is normal to the major dimension of the Hall-effect sensor. More than one measurement should be taken to ensure consistent readings. The Hall-effect probe may be placed within the coil or outside the vicinity of the coil if the part is longer than the width of the coil. On parts with more than one diameter/thickness, multiple measurements should be taken to ensure a minimum measurement of 30 gauss on all areas to be examined. Measurement is made of the applied field, that is, during the magnetizing shot, not the residual flux field.

14.2.4 Using Empirical Formulas—Appendix X3 details the use of empirical formulas for determining field strength. Amperages derived from empirical formulas should be verified with a Hall-effect gaussmeter or AS 5371 shims.

14.3 Localized Magnetization:

14.3.1 Using Prods—When using prods on material $\frac{3}{4}$ in. (19 mm) in thickness or less, it is recommended to use 90 to

115 A/in. of prod spacing (3.5 to 4.5 A/mm). For material greater than $\frac{3}{4}$ in. (19 mm) in thickness, it is recommended to use 100 to 125 A/in. of prod spacing. Prod spacing is recommended to be not less than 2 in. (50 mm) or greater than 8 in. (200 mm). The effective width of the magnetizing field when using prods is one fourth of the prod spacing on each side of a line through the prod centers.

14.3.2 Using Yokes—The field strength of a yoke (or a permanent magnet) can be empirically determined by measuring its lifting power (see 20.3.7). If a Hall-effect probe is used, it shall be placed on the surface midway between the poles.

15. Application of Dry and Wet Magnetic Particles

15.1 Dry Magnetic Particles:

15.1.1 Magnetic Fields for Dry Particles—Dry magnetic powders are generally applied with the continuous magnetizing techniques. When utilizing AC, the current must be on before application of the dry powder and remain on through the examination phase. With Half-wave rectified AC or yoke DC magnetization, a current duration of at least $\frac{1}{2}$ s should be used. The current duration should be short enough to prevent any damage from overheating or from other causes. It should be noted that AC and half-wave rectified DC impart better particle mobility to the powder than DC or full-wave rectified AC. Dry magnetic powders are widely used for magnetic particle examination of large parts as well as on localized areas such as welds. Dry magnetic particles are widely used for oil field applications and are frequently used in conjunction with capacitor discharge style equipment and the residual method.

15.1.2 Dry Powder Application—It is recommended that dry powders be applied in such a manner that a light uniform, dust-like coating settles upon the surface of the part/piece while it is being magnetized. Dry particles must not be applied to a damp surface; they will have limited mobility. Neither should they be applied where there is excessive wind. The preferred application technique suspends the particles in air in such a manner that they reach the part surface being magnetized in a uniform cloud with a minimum of force. Usually,

specially designed powder blowers and hand powder applicators are employed (see Fig. 1). Dry particles should not be applied by pouring, throwing, or spreading with the fingers.

15.1.3 *Excess Powder Removal*—Care is needed in both the application and removal of excess dry powder. Removal of excess powder is generally done while the magnetizing current is present and care must be exercised to prevent the removal of particles attracted by a leakage field, which may prove to be a relevant indication.

15.1.4 *Near-surface Discontinuities Powder Patterns*—In order to recognize the broad, fuzzy, weakly held powder patterns produced by near-surface discontinuities, it is essential to observe carefully the formation of indications while the powder is being applied and also while the excess is being removed. Sufficient time for indication formation and examination should be allowed between successive magnetization cycles.

15.2 *Wet Particle Application*—Wet magnetic particles, fluorescent or nonfluorescent, suspended in a vehicle at a recommended concentration may be applied either by spraying or flowing over the areas to be examined during the application of the magnetizing field current (continuous technique) or after turning off the current (residual technique). Proper sequencing of operation (part magnetization and timing of bath application) is essential to indication formation and retention. For the continuous technique multiple current shots should be applied. The last shot should be applied after the particle flow has been diverted and while the particle bath is still on the part. A single shot may be sufficient. Care should be taken to prevent damage to a part due to overheating or other causes. Since fine or weakly held indications on highly finished or polished surfaces may be washed away or obliterated, care must be taken to prevent high-velocity flow over critical surfaces and to cut off the bath application before removing the magnetizing force. Discontinuity detection may benefit from an extended drain time of several seconds before actual examination.

15.3 *Magnetic Slurry/Paints*—Magnetic slurry/paints are applied to the part with a brush before or during part magnetization. Indications appear as a dark line against a light silvery background. Magnetic slurry is ideal for overhead or underwater magnetic particle examination.

15.4 *Magnetic Polymers*—Magnetic polymers are applied to the part to be examined as a liquid polymer suspension. The part is then magnetized, the polymer is allowed to cure, and the elastic coating is removed from the examination surface for interpretation and evaluation. Care must be exercised to ensure that magnetization is completed within the active migration period of the polymer which is usually about 10 min. This method is particularly applicable to areas of limited visual access such as bolt holes. Detailed application and use instructions of the manufacturer should be followed for optimum results.

15.5 *White Background and Black Oxide*—A thin white background is applied by aerosol to provide a thin (≤ 2 mil), smooth, high contrast background prior to magnetization and particle application. After background has dried, magnetization and particle application follow normal procedures. The high contrast between the white background and black particles

provides high sensitivity in white light conditions. Detailed application and use instructions of the manufacturer should be followed for optimum results.

16. Interpretation of Indications

16.1 *Valid Indications*—All valid indications formed by magnetic particle examination are the result of magnetic leakage fields. Indications may be relevant (16.1.1), nonrelevant (16.1.2), or false (16.1.3).

16.1.1 *Relevant Indications*—Relevant indications are produced by leakage fields which are the result of discontinuities. Relevant indications require evaluation with regard to the acceptance standards agreed upon between the manufacturer/test agency and the purchaser (see Annex A1).

16.1.2 *Nonrelevant Indications*—Nonrelevant indications can occur singly or in patterns as a result of leakage fields created by conditions that require no evaluation such as changes in section (like keyways and drilled holes), inherent material properties (like the edge of a bimetallic weld), magnetic writing, etc.

16.1.3 *False Indications*—False indications are not the result of magnetic forces. Examples are particles held mechanically or by gravity in shallow depressions or particles held by rust or scale on the surface.

17. Recording of Indications

17.1 *Means of Recording*—When required by a written procedure, permanent records of the location, type, direction, length(s), and spacing(s) of indications may be made by one or more of the following means.

17.1.1 *Sketches*—Sketching the indication(s) and their locations.

17.1.2 *Transfer (Dry Powder Only)*—Covering the indication(s) with transparent adhesive-backed tape, removing the tape with the magnetic particle indication(s) adhering to it, and placing it on paper or other appropriate background material indicating locations.

17.1.3 *Strippable Film (Dry Powder Only)*—Covering the indication(s) with a spray-on strippable film that fixes the indication(s) in place. When the film is stripped from the part, the magnetic particle indication(s) adhere to it.

17.1.4 *Photographing*—Photographing the indications themselves, the tape, or the strippable film reproductions of the indications.

17.1.5 *Written Records*—Recording the location, length, orientation, and number of indications.

17.1.5.1 *Defect or Indication Sizing Accuracy*—For situations where defect or indication size limits are specified by the acceptance criteria, measurement equipment should be selected with an accuracy being precise enough to determine compliance. For example, to verify maximum defect length does not exceed 0.150 in. (3.81 mm) a measuring device accurate to ± 0.010 in. (0.254 mm) could be used by reducing the allowable limit to 0.140 in. (3.56 mm), but using a measuring device accurate to ± 0.150 in. (3.81 mm) or one with 0.100 in. (2.54 mm) increments is not accurate enough.

17.1.5.2 For situations where no defect or indication tolerances are specified (for example, reporting the length of a crack when the acceptance criteria is “No cracks allowed”) the crack

length should not be reported with more precision than the resolution of the measurement equipment allows. For example, when using a measuring device accurate to ± 0.010 in. (0.254 mm) report the crack length in 0.010 in. (0.254 mm) increments.

17.1.5.3 Some contracts may require better than the minimum measurement accuracy needed to determine compliance. These situations are generally limited to critical direct measurement of deliverable product features, rather than examination parameter checks. For example, an accuracy ratio of 2 to 1 may be specified for measurement of defects or product geometry, which means an instrument with a calibrated accuracy of ± 0.005 in. (0.127 mm) would be needed for verifying or reporting dimensions to the nearest ± 0.010 in. (0.254 mm).

17.2 *Accompanying Information*—A record of the procedure parameters listed below as applicable should accompany the examination results:

17.2.1 *Method Used*—Magnetic particle method (dry, wet, fluorescent, etc.).

17.2.2 *Magnetizing Technique*—Magnetizing technique (continuous, true-continuous, residual).

17.2.3 *Current Type*—Magnetizing current (AC, half-wave rectified or full-wave rectified AC, etc.).

17.2.4 *Field Direction*—Direction of magnetic field (prod placement, cable wrap sequence, etc.).

17.2.5 *Field Strength*—Magnetic current strength (ampere turns, amperes per inch (millimetre) of prod spacing, lifting force, etc.).

18. Demagnetization

18.1 *Applicability*—All ferromagnetic material will retain some residual magnetism, the strength of which is dependent on the retentivity of the part. Residual magnetism does not affect the mechanical properties of the part. However, a residual field may cause chips, filing, scale, etc. to adhere to the surface affecting subsequent machining operations, painting, or plating. Additionally, if the part will be used in locations near sensitive instruments, high residual fields could affect the operation of these instruments. Furthermore, a strong residual magnetic field in a part to be welded or electroplated could interfere with welding or plating process. Residual fields may also interfere with later magnetic particle examination. Demagnetization is required only if specified in the drawings, specification, or purchase order. When required, an acceptable level of residual magnetization and the measuring method should also be specified. See 18.3.

18.2 *Demagnetization Methods*—The ease of demagnetization is dependent on the coercive force of the metal. High retentivity is not necessarily related to high coercive force in that the strength of the residual field is not always an indicator of ease of demagnetizing. In general, demagnetization is accomplished by subjecting the part to a field equal to or greater than that used to magnetize the part and in nearly the same direction, then continuously reversing the field direction while gradually decreasing it to zero.

18.2.1 *Withdrawal from Alternating Current Coil*—The fastest and most simple technique is to pass the part through a high intensity alternating current coil and then slowly withdraw the part from the field of the coil. A coil of 5000 to 10,000

ampere turns is recommended. Line frequency is usually from 50 to 60 Hz alternating current. The piece should enter the coil from a 12-in. (300-mm) distance and move through it steadily and slowly until the piece is at least 36 in. (900 mm) beyond the coil. Care should be exercised to ensure that the part is entirely removed from the influence of the coil before the demagnetizing force is discontinued, otherwise the demagnetizer may have the reverse effect and actually remagnetize the part. This should be repeated as necessary to reduce the residual field to an acceptable level. See 18.3. Small parts of complex figuration can be rotated and tumbled while passing through the field of the coil. Use of this technique may not be effective on large parts in which the alternating magnetic current field is insufficient to penetrate.

18.2.2 *Decreasing Alternating Current*—An alternative technique for part demagnetization is subjecting the part to the alternating magnetic field while gradually reducing its strength to a desired level.

18.2.3 *Demagnetizing with Yokes*—Alternating current yokes may be used for local demagnetization by placing the poles on the surface, moving them around the area, and slowly withdrawing the yoke while it is still energized.

18.2.4 *Reversing Direct Current*—The part to be demagnetized is subjected to consecutive steps of reversed and reduced direct current magnetization to a desired level. (This is the most effective process of demagnetizing large parts in which the alternating current field has insufficient penetration to remove the internal residual magnetization.) This technique requires special equipment for reversing the current while simultaneously reducing it in small increments.

18.3 *Extent of Demagnetization*—The effectiveness of the demagnetizing operation can be indicated by the use of appropriate magnetic field indicators. (**Warning**—A part may retain a strong residual field after having been circularly magnetized and exhibit little or no external evidence of this field. Therefore, the circular magnetization should be conducted before longitudinal magnetization if complete demagnetization is required. If a sacrificial part is available, in the case of a part such as a bearing race that has been circularly magnetized, it is often advisable to section one side of it and measure the remaining leakage field in order to check the demagnetizing process.)

18.3.1 After demagnetization, measurable residual fields should not exceed a value agreed upon or as specified on the engineering drawing or in the contract, purchase order, or specification.

19. Post Examination Cleaning

19.1 *Particle Removal*—Post-examination cleaning is necessary where magnetic particle material(s) could interfere with subsequent processing or with service requirements. Demagnetization should always precede particle removal. The purchaser should specify when post-examination cleaning is needed and the extent required.

19.2 *Means of Particle Removal*—Typical post-examination cleaning techniques employed are: (a) the use of compressed air to blow off unwanted dry magnetic particles; (b) drying of wet particles and subsequent removal by brushing or with compressed air; (c) removal of wet particles by flushing with

solvent; and (d) other suitable post-examination cleaning techniques may be used if they will not interfere with subsequent requirements.

20. Process Controls

20.1 *Contributing Factors*—The overall performance of a magnetic particle testing system is dependent upon the following:

20.1.1 Operator capability, if a manual operation is involved.

20.1.2 Control of process steps.

20.1.3 The particles or suspension, or both.

20.1.4 The equipment.

20.1.5 Visible light level.

20.1.6 Black light monitoring where applicable.

20.1.7 Magnetic field strength.

20.1.8 Field direction or orientation.

20.1.9 Residual field strength.

20.1.10 These factors should all be controlled individually.

20.2 *Maintenance and Calibration of Equipment*—The magnetic particle equipment employed should be maintained in proper working order at all times. The frequency of verification calibration, usually every six months, see [Table 2](#), or whenever a malfunction is suspected, should be specified in the written procedures of the nondestructive testing facility. Records of the checks and results provide useful information for quality control purposes and should be maintained. In addition, any or all of the checks described should be performed whenever a malfunction of the system is suspected. Calibration checks should be conducted in accordance with the specifications or documents that are applicable.

20.2.1 *Equipment Calibration*—It is good practice that all calibrated equipment be traceable to the job it was used on. This facilitates possible re-examination or evaluation should a piece of equipment be found not working properly.

20.2.2 Some examination procedures may require equipment calibration or operational checks, but no accuracy requirement is specified, for that equipment, by the contractually specified magnetic particle examination procedure (for ex-

ample, ASTM [E1444](#) light meters and gaussmeter accuracy), however the accuracy of the measuring device should be reasonably suited for the situation with the resolution of the equipment being precise enough to determine compliance.

20.2.3 Equipment that meets an accuracy requirement specified by the contractually specified magnetic particle examination procedure (for example, ASTM [E1444](#) ammeter accuracy of $\pm 10\%$ or 50 amperes, or a timer control ± 0.01 second) should be considered adequate, with no additional accuracy or uncertainty determination needed.

20.2.4 Measurement equipment that the contractually specified magnetic particle inspection procedure does not specifically require to be calibrated or meet a specified accuracy (for example, timers, shop air pressure gauge, etc.) should be maintained in good working order and have measurement resolution reasonably suited for the intended use.

20.3 *Equipment Checks*—The following checks are recommended for ensuring the accuracy of magnetic particle magnetizing equipment.

20.3.1 *Ammeter Accuracy*—The equipment meter readings should be compared to those of a control check meter incorporating a shunt or current transformer connected to monitor the output current. The accuracy of the entire control check meter arrangement should be verified at six-month intervals or as agreed upon between the purchaser and supplier by a means traceable to the National Institute of Standards and Technology (NIST). Comparative readings should be taken at a minimum of three output levels encompassing the usable range. The equipment meter reading should not deviate by more than $\pm 10\%$ of full scale relative to the actual current values as shown by the check meter. (**Warning**—When measuring half-wave DC, the direct current reading of a conventional DC check meter reading should be doubled.)

20.3.2 *Timer Control Check*—On equipment utilizing a timer to control the duration of the current flow, the timer should be checked for accuracy as specified in [Table 2](#) or whenever a malfunction is suspected. The timer should be calibrated to within ± 0.1 seconds using a suitable electronic timer.

20.3.3 *Magnetic Field Quick Break Check*—On equipment that has a quick break feature, the functioning of this circuit should be checked and verified. This check may be performed using a suitable oscilloscope or a simple test device usually available from the manufacturer. Normally, only the fixed coil is checked for quick break functionality. Headstocks would need to be checked only if cables are attached to the headstocks to form a coil wrap. On electronic power packs or machines, failure to achieve indication of a “quick break” would indicate that a malfunction exists in the energizing circuit.

20.3.4 *Equipment Current Output Check*—To ensure the continued accuracy of the equipment, ammeter readings at each transformer tap should be made with a calibrated ammeter-shunt combination. This accessory is placed in series with the contacts. The equipment shunt should not be used to check the machine of which it is a part. For infinite current control units (non-tap switch), settings at 500-A intervals should be used. On uni-directional equipment, variations exceeding $\pm 10\%$ from the equipment ammeter readings

TABLE 2 Recommended Verification Intervals

Item	Maximum Time Between Verifications ^A	Reference Paragraphs
Lighting:		
Visible light intensity	1 week	7.1.1
Black light intensity	1 day	7.1.2
Ambient visible light intensity	1 week ^A	7.1.1
System performance using test piece or ring specimen of Fig. 13	1 day	20.8
Wet particle concentration	8 h, or every shift change	20.6
Wet particle contamination	1 week	20.6.4
Water break check	1 day	20.7.5
Equipment calibration/check:		
Ammeter accuracy	6 months	20.3.1
Timer control	6 months	20.3.2
Quick break	6 months	20.3.3
Hall-effect gaussmeter	6 months	20.3.6
Dead weight check	6 months	20.3.7
Light meter checks	6 months	20.4

^A Note—The maximum time between verifications may be extended when substantiated by actual technical stability/reliability data.

indicate the equipment needs service or repair. On multi-vector equipment, variations exceeding $\pm 5\%$ from the equipment ammeter readings indicate the equipment needs service or repair.

20.3.5 Internal Short Circuit Check—Magnetic particle equipment should be checked periodically for internal short circuiting. With the headstocks set for maximum amperage output, any deflection of the ammeter when the current is activated with no conductor between the contacts is an indication of an internal short circuit and must be repaired prior to use.

20.3.6 Hall-effect Meters—Depending upon the manufacturer, meters are normally accurate for use with full-wave DC only. Hall-effect meter readings for HW and AC current applications should be correlated to the results of the application of **AS 5371** shims. Hall-effect gaussmeters should be calibrated every six months in accordance with the manufacturer’s instructions.

NOTE 1—When used with SCR controlled equipment, the Gaussmeter’s accuracy is dependant upon the actual circuit design of each model meter and results may vary.

20.3.7 Electromagnetic Yoke Lifting Force Check—The magnetizing force of a yoke (or a permanent magnet) should be checked by determining its lifting power on a steel plate. See **Table 3**. The lifting force relates to the electromagnetic strength of the yoke.

20.3.8 Powder Blower—The performance of powder blowers used to apply the dry magnetic particles should be checked at routine intervals or whenever a malfunction is suspected. The check should be made on a representative examination part. The blower should coat the area under evaluation with a light, uniform dust-like coating of dry magnetic particles and have sufficient force to remove the excess particles without disturbing those particles that are evidence of indications. Necessary adjustments to the blower’s flow rate or air velocity should be made in accordance with the manufacturer’s recommendations.

20.4 Examination Area Light Level Control:

20.4.1 Visible Light Intensity—Light intensity in the examination area should be checked at specified intervals with the designated light meter at the surface of the parts being examined. See **Table 2**.

20.4.2 Black (ultraviolet) Light Intensity—Black light intensity and wavelength should be checked at the specified intervals but not to exceed one-week intervals and whenever a bulb is changed. Reflectors and filters should be cleaned daily and checked for integrity. See **Table 2**. Cracked or broken UV filters should be replaced immediately. Defective bulbs which radiate UV energy must also be replaced before further use.

20.5 Dry Particle Quality Control Checks—In order to assure uniform and consistent performance from the dry

magnetic powder selected for use, it is advisable that all incoming powders be certified or checked for conformance with quality control standards established between the user and supplier.

20.5.1 Contamination:

20.5.1.1 Degradation Factors—Dry magnetic particles are generally very rugged and perform with a high degree of consistency over a wide process envelope. Their performance, however, is susceptible to degradation from such contaminants as moisture, grease, oil, rust and mill scale particles, nonmagnetic particles such as foundry sand, and excessive heat. These contaminants will usually manifest themselves in the form of particle color change and particle agglomeration, the degree of which will determine further use of the powder. Over-heated dry particles can lose their color, thereby reducing the color contrast with the part and thus hinder part examination. Particle agglomeration can reduce particle mobility during processing, and large particle agglomerates may not be retained at an indication. Dry particles should not be recycled as fractionation, the subsequent depletion of finer particles from the aggregate powder composition, degrades the quality of the particles.

20.5.1.2 Ensuring Particle Quality—To ensure against deleterious effects from possible contaminants, it is recommended that a routine performance check be conducted (see **20.8.3**).

20.6 Wet Particle Quality Control Checks—The following checks for wet magnetic particle suspensions should be conducted at startup and at regular intervals to assure consistent performance. See **Table 2**. Since bath contamination will occur as the bath is used, monitoring the working bath at regular intervals is essential.

20.6.1 Determining Bath Concentration—Bath concentration and sometimes bath contamination are determined by measuring its settling volume through the use of a pear-shaped centrifuge tube with a 1-mL stem (0.05-mL divisions) for fluorescent particle suspensions or a 1.5-mL stem (0.1-mL divisions) for nonfluorescent suspensions. (See **Appendix X5**.) Before sampling, the suspension should be run through the recirculating system for at least 30 min to ensure thorough mixing of all particles which could have settled on the sump screen and along the sides or bottom of the tank. Take a 100-mL portion of the suspension from the hose or nozzle into a clean, non-fluorescing centrifuge tube, demagnetize and allow it to settle for approximately 60 min with petroleum distillate suspensions or 30 min with water-based suspensions before reading. These times are average times based upon the most commonly used products; actual times should be adjusted so that the particles have substantially settled out of suspension. The volume settling out at the bottom of the tube is indicative of the particle concentration in the bath.

20.6.2 Sample Interpretation—If the bath concentration is low in particle content, add a sufficient amount of particle materials to obtain the desired concentration; if the suspension is high in particle content, add sufficient vehicle to obtain the desired concentration. If the settled particles appear to be loose agglomerates rather than a solid layer, take a second sample. If still agglomerated, the particles may have become magnetized; replace the suspension.

TABLE 3 Minimum Yoke Lifting Force

Type Current	Yoke Pole Leg Spacing	
	2 to 4 in. (50 to 100 mm)	4 to 6 in. (100 to 150 mm)
AC	10 lb (45 N)	
DC	30 lb (135 N)	50 lb (225 N)

20.6.3 *Settling Volumes*—For fluorescent particles, the recommended settling volume (see 15.2) is from 0.1 to 0.4 mL in a 100-mL bath sample and from 1.2 to 2.4 mL per 100 mL of vehicle for non-fluorescent particles, unless otherwise approved by the Cognizant Engineering Organization (CEO). Refer to appropriate AMS document (3041, 3042, 3043, 3044, 3045, and/or 3046). For dual-colored particles, the recommended settling volume should be determined by the performance requirements and lighting environment of a given application as recommended by the manufacturer. See 8.5.5.

20.6.4 *Bath Contamination*—Both fluorescent and nonfluorescent suspensions should be checked periodically for contaminants such as dirt, scale, oil, lint, loose fluorescent pigment, water (in the case of oil suspensions), and particle agglomerates which can adversely affect the performance of the magnetic particle examination process. See Table 2.

20.6.4.1 *Carrier Contamination*—For fluorescent baths, the liquid directly above the precipitate should be evaluated with black light. The liquid will have a little fluorescence. Its color can be compared with a freshly made-up sample using the same materials or with an unused sample from the original bath that was retained for this purpose. If the “used” sample is noticeably more fluorescent than the comparison standard, the bath should be replaced.

20.6.4.2 *Particle Contamination*—The graduated portion of the tube should be evaluated under black light if the bath is fluorescent and under visible light (for both fluorescent and nonfluorescent particles) for striations or bands, differences in color or appearance. Bands or striations may indicate contamination. If the total volume of the contaminates, including bands or striations exceeds 30 % of the volume of magnetic particles, or if the liquid is noticeably fluorescent (see 20.6.4.1), the bath should be replaced.

20.6.5 *Particle Durability*—The durability of both the fluorescent and nonfluorescent magnetic particles in suspension should be checked periodically to ensure that the particles have not degraded due to chemical attack from the suspending oil or conditioned water vehicles or mechanically degraded by the rotational forces of the recirculating pump in a wet horizontal magnetic particle unit. Fluorescent magnetic particle breakdown in particular can result in a decrease in sensitivity and an increase in nonmagnetic fluorescent background. Lost fluorescent pigment can produce false indications that can interfere with the examination process.

20.6.6 *Fluorescent Brightness*—It is important that the brightness of fluorescent magnetic particle powder be maintained at the established level so that indication and background brightness can be kept at a relatively constant level. Variations in contrast can noticeably affect examination results. Lack of adequate contrast is generally caused by:

20.6.6.1 An increase in contamination level of the vehicle increasing background fluorescence, or

20.6.6.2 Loss of vehicle because of evaporation, increasing concentration, or

20.6.6.3 Degradation of fluorescent particles. A change in contrast ratio can be observed by using a verification ring specimen with an etched surface.

20.6.7 *System Performance*—Failure to find a known discontinuity in a part or obtain the specified indications on the test ring (see 20.8.4) indicates a need for changing of the entire bath. If a part was used, it must have been completely demagnetized and cleaned so that no fluorescent background can be detected when viewed under black light with a surface intensity of at least 1000 $\mu\text{W}/\text{cm}^2$. If any background is noted that interferes with either detection or interpretation, the bath should be drained and a new suspension made.

20.6.8 *Magnetic Stripe Cards*—The encoded pattern on the magnetic stripes of magnetic stripe cards may serve as a verification piece for the evaluation of particle sensitivity. Particles are attracted to magnetic gradients formed when the stripe has been encoded. See Appendix X4 for further information.

20.7 *Bath Characteristics Control:*

20.7.1 *Oil Bath Fluids*—Properties of oil-bath fluids are described in AMS 2641 or A-A-59230.

20.7.2 *Water Bath Fluids*—Properties of conditioned water-bath fluids are described in AS 4792.

20.7.3 *Viscosity*—The recommended viscosity of the suspension is not to exceed 5 mm^2/s (5.0 cSt), at any temperature at which the bath may be used, when verified in accordance with Test Method D445.

20.7.4 *Flash Point*—The recommended flash point of wet magnetic particle light petroleum distillate suspension is a minimum of 200°F (93°C); use Test Method D93.

20.7.5 *Water Break Check for Conditioned Water Vehicles*—Properly conditioned water will provide proper wetting, particle dispersion, and corrosion protection. The water break check should be performed by flooding a part, similar in surface finish to those under examination, with suspension, and then noting the appearance of the surface of the part after the flooding is stopped. If the film of suspension is continuous and even all over the part, sufficient wetting agent is present. If the film of suspension breaks, exposing bare surfaces of the part, and the suspension forms many separate droplets on the surface, more wetting agent is needed or the part has not been sufficiently cleaned. When using the fluorescent method, this check should be performed under both blacklight and whitelight.

20.7.6 *pH of Conditioned Water Vehicles*—The recommended pH of the conditioned water bath is between 7.0 and 10.5 as determined by a suitable pH meter or special pH paper.

20.8 *Verifying System Performance*—System performance checks must be conducted in accordance with a written procedure so that the verification is performed in the same manner each time.

20.8.1 *Production Verification Parts with Discontinuities*—A practical way to evaluate the performance and sensitivity of the dry or wet magnetic particles or overall system performance, or both, is to use representative verification parts with known discontinuities of the type and severity normally encountered during actual production examination. However, the usefulness of such parts is limited because the orientation and magnitude of the discontinuities cannot be controlled. The use of flawed parts with gross discontinuities is

not recommended. (**Warning**—If such parts are used, they must be thoroughly demagnetized and cleaned after each use.)

20.8.2 *Fabricated Test Parts with Discontinuities*—Often, production verification parts with known discontinuities of the type and severity needed for evaluation are not available. As an alternative, fabricated verification specimens with discontinuities of varying degree and severity can be used to provide an indication of the effectiveness of the dry or wet magnetic particle examination process. If such parts are used, they should be thoroughly demagnetized and cleaned after each use.

20.8.3 *Test Plate*—A magnetic particle system performance verification plate, such as shown in Fig. 13 is useful for checking the overall performance of wet or dry techniques using prods and yokes. Recommended minimum dimensions are ten inches per side and nominal thickness of one inch. Discontinuities can be formed by controlled heating/cooling, EDM notches, artificial discontinuities in accordance with 14.2.2 or other means. (**Warning**—Notches should be filled flush to the surface with a nonconducting material, such as epoxy, to prevent the mechanical holding of the indicating medium.)

20.8.4 *Test Ring Specimen*—A verification (Ketos) ring specimen may also be used in evaluating and comparing the

overall performance and sensitivity of both dry and wet, fluorescent and non-fluorescent magnetic particle techniques using a central conductor magnetization technique. Refer to Practice E1444, Appendix X1.

20.8.4.1 *Using the Test Ring*—If using the verification ring, place a conductor with a diameter between 1 and 1.25 in. (25 and 31 mm) through the center of the ring. Center the ring on the length of the conductor. Magnetize the ring circularly by passing the current through the conductor as described in Appendix X1 of Practice E1444. Gently apply particles to the surface of the ring while the current is flowing. Examine the ring within one minute after current application. The number of hole indications visible should meet or exceed those as specified in Appendix X1 of Practice E1444.

20.8.5 *Magnetic Field Indicators*:

20.8.5.1 *“Pie” Field Indicator*—The magnetic field indicator shown in Fig. 14 relies on the slots between the pie shaped segments to show the presence and the approximate direction of the external magnetic field. Because “pie” field indicators are constructed of highly permeable material with 100 % through wall flaws, indications do not mean that suitable field strength is present for the location of relevant indications in the part under examination. The “pie” field indicator is used with

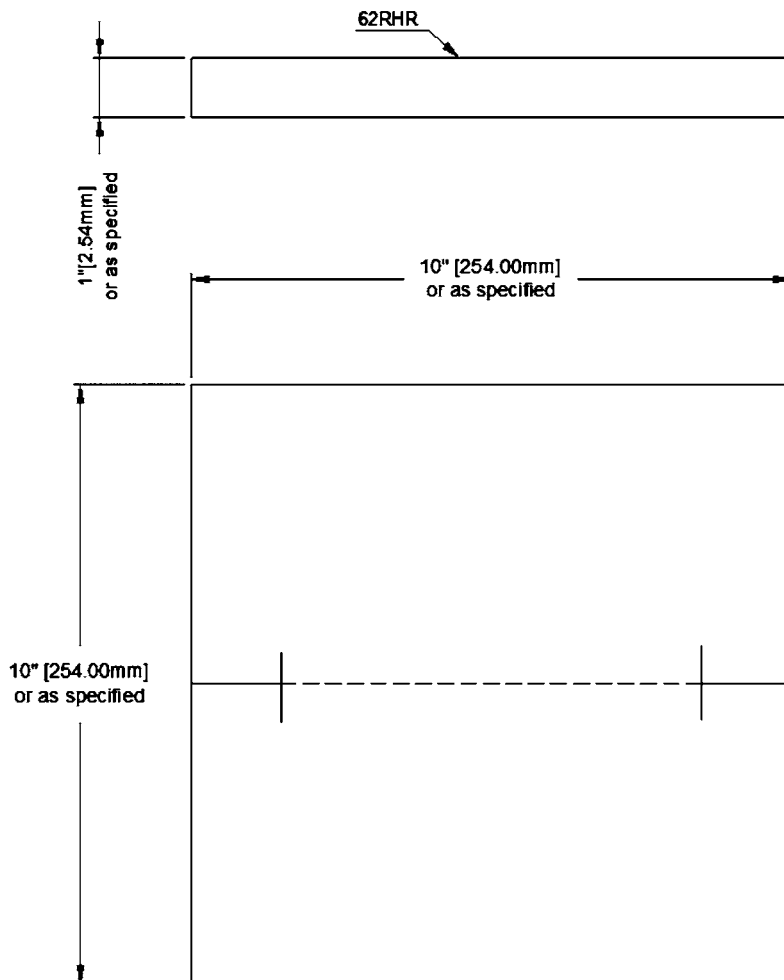

FIG. 13 Sample of a Magnetic Particle Performance Verification Plate. Defects are formed and located in accordance with plate manufacturers’ specifications.

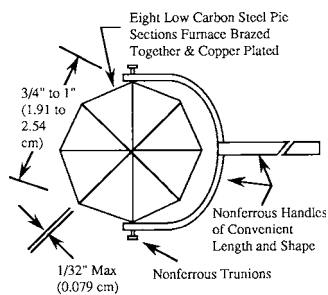

FIG. 14 Magnetic Field Indicator

the magnetic particles applied across the copper face of the indicator (the slots are against the piece) simultaneously with the magnetizing force. Typical “pie” field indicators show a clear indication in a five gauss external field. These devices are generally used as instructional aids.

20.8.5.2 *Slotted Shims*—Several types of slotted shims exist. Refer to [AS 5371](#) and to illustrations in [Appendix X2](#).

21. Procedures

21.1 When specified a procedure should be written for all magnetic particle examinations and should include as a minimum the following information. A sketch is usually used for illustrating part geometry, techniques, and areas for examination. This sketch may also be used for recording location of magnetic field indicators and for recording location of discontinuities.

- 21.1.1 Area to be examined (entire part or specific area),
- 21.1.2 Type of magnetic particle material (dry or wet, visible or fluorescent),
- 21.1.3 Magnetic particle equipment,
- 21.1.4 Part surface preparation requirements,
- 21.1.5 Magnetizing process (continuous, true-continuous, residual),
- 21.1.6 Magnetizing current (alternating, half-wave rectified AC, full-wave rectified AC, direct),
- 21.1.7 Means of establishing part magnetization (direct-prods, head/tailstock contact or cable wrap, indirect-coil/cable wrap, yoke, central conductor, and so forth),
- 21.1.8 Direction of magnetic field (circular or longitudinal),
- 21.1.9 System performance/sensitivity checks,
- 21.1.10 Magnetic field strength (ampere turns, field density, magnetizing force, and number and duration of application of magnetizing current),
- 21.1.11 Application of examination media,
- 21.1.12 Interpretation and evaluation of indications,
- 21.1.13 Type of records including accept/reject criteria,
- 21.1.14 Demagnetizing techniques, if required, and
- 21.1.15 Post-examination cleaning, if required,
- 21.2 *Written Reports*—Written reports should be prepared as agreed upon between the testing agency/department and the purchaser/user.

22. Acceptance Standards

22.1 The acceptability of parts examined by this method is not specified herein. Acceptance standards are a matter of

agreement between the manufacturer and the purchaser and should be stated in a referenced contract, specification, or code.

23. Safety

23.1 Those involved with hands-on magnetic particle examination exposure to hazards include:

23.1.1 *Electric Shock and Burns*—Electric short circuits can cause shock and particularly burns from the high amperages at relatively low voltages that are used. Equipment handling water suspensions should have good electrical grounds.

23.1.2 *Flying Particles*—Magnetic particles, particularly the dry ones, dirt, foundry sand, rust, and mill scale can enter the eyes and ears when they are blown off the part when applying them to a vertical or overhead surface or when cleaning an examined surface with compressed air. Dry particles are easy to inhale and the use of a dust respirator is recommended.

23.1.3 *Falls*—A fall from a scaffold or ladder if working on a large structure in the field or shop.

23.1.4 *Fire*—Ignition of a petroleum distillate bath.

23.1.5 *Environment*—Doing magnetic particle examination where flammable vapors are present as in a petrochemical plant or oil refinery. Underwater work has its own set of hazards and should be addressed independently.

23.1.6 *Wet Floors*—Slipping on a floor wetted with a particle suspension.

23.1.7 *Shifting or Dropping of Large Components*—Large components, especially those on temporary supports can shift during examination or fall while being lifted. In addition, operators should be alert to the possibility of injury to body members being caught beneath a sling/chain or between head/tail stock and the piece.

23.1.8 *Ultraviolet Light Exposure*—Ultraviolet light can adversely affect the eyes and skin. Safety goggles designed to absorb UV wavelength radiation are suggested where high intensity blacklight is used.

23.1.9 *Materials and Concentrates*—The safe handling of magnetic particles and concentrates are governed by the supplier’s Material Safety Data Sheets (MSDS). The MSDS conforming to 29 CFR 1910.1200 or equivalent must be provided by the supplier to any user and must be prepared in accordance with FED-STD-313.

23.1.10 *Equipment Hazards*—Because of the large breadth of equipment available, unique safety hazards may exist and should be addressed on a case by case basis.

24. Precision and Bias

24.1 The methodology described in the practice will produce repeatable results provided the field has the proper orientation with respect to the discontinuities being sought.

24.2 It must be recognized that the surface condition of the material being examined, the material’s magnetic properties, its shape, and control of the factors listed in [20.1](#) influence the results obtained.

25. Keywords

25.1 dye; evaluation; examination; fluorescent; inspection; magnetic particle; nondestructive; testing

ANNEX

(Mandatory Information)

A1. TYPICAL MAGNETIC PARTICLE INDICATIONS

A1.1 Surface discontinuities with few exceptions produce sharp and distinct magnetic particle indications. Near-surface discontinuities on the other hand produce less distinct or fuzzy magnetic particle indications in comparison to surface discontinuities; the magnetic particle indications are broad rather than sharp and the particles are less tightly held.

A1.2 *Wet Method:*

A1.2.1 *Fluorescent*—Indications of surface cracks, surface indications, and an indication of a near surface discontinuity are shown in [Figs. A1.1-A1.6](#).

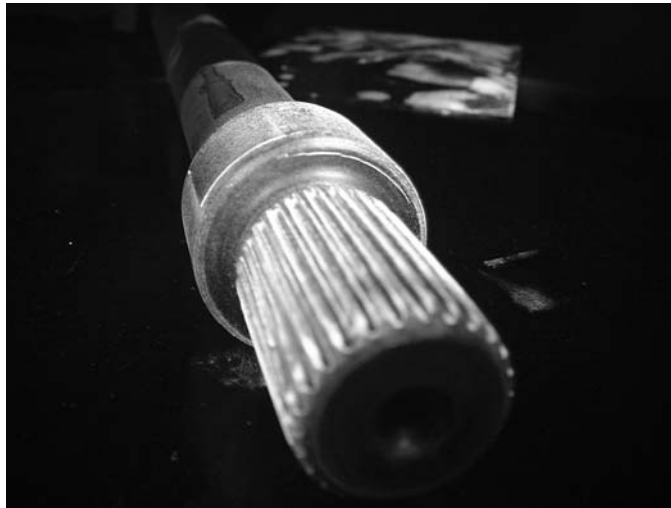

FIG. A1.1 Axle with Circumferential Crack in Shoulder

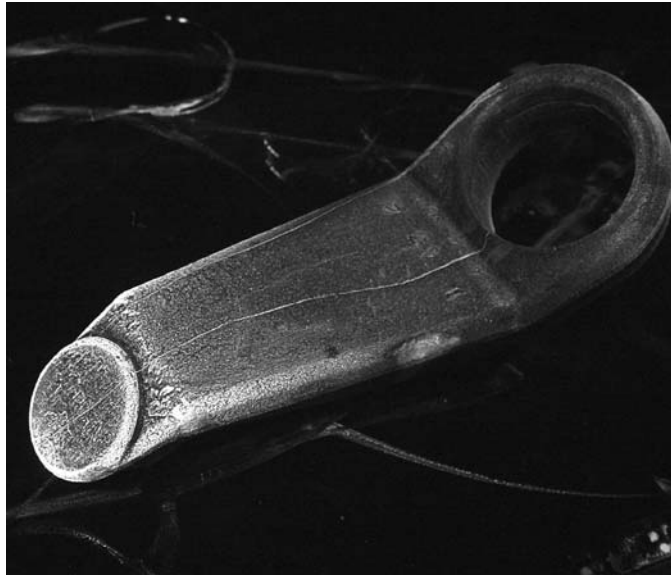

FIG. A1.2 Arm with Two Longitudinal Indications



FIG. A1.3 Hub with Both Radial and Longitudinal Indications

A1.2.2 *Nonfluorescent*—Indications of surface cracks are shown in [Figs. A1.7-A1.16](#).

A1.3 *Dry Method*—Indications of surface cracks are shown

in [Figs. A1.17-A1.23](#).

A1.4 Nonrelevant indications are shown in [Figs. A1.24-A1.26](#).



FIG. A1.4 Crankshaft with Various Longitudinal Indications

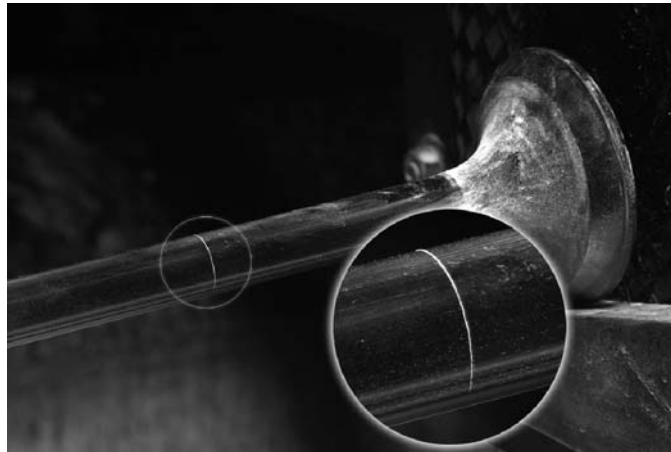

FIG. A1.5 Valve with Indication on the Stem



FIG. A1.6 Yoke Showing Balanced QQIs

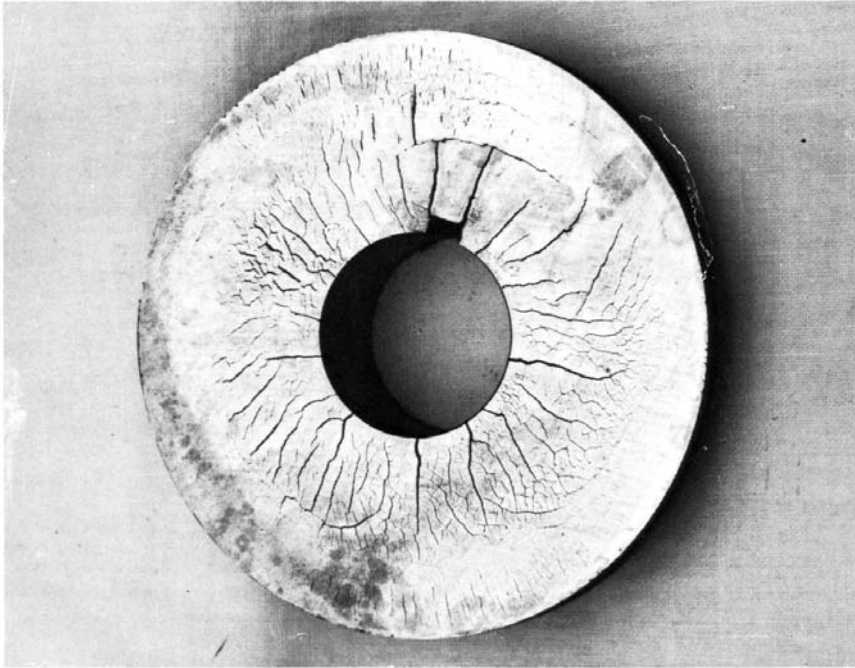

FIG. A1.7 Indications of Surface Cracking (Produced by Central Conductor Magnetization DC Continuous)

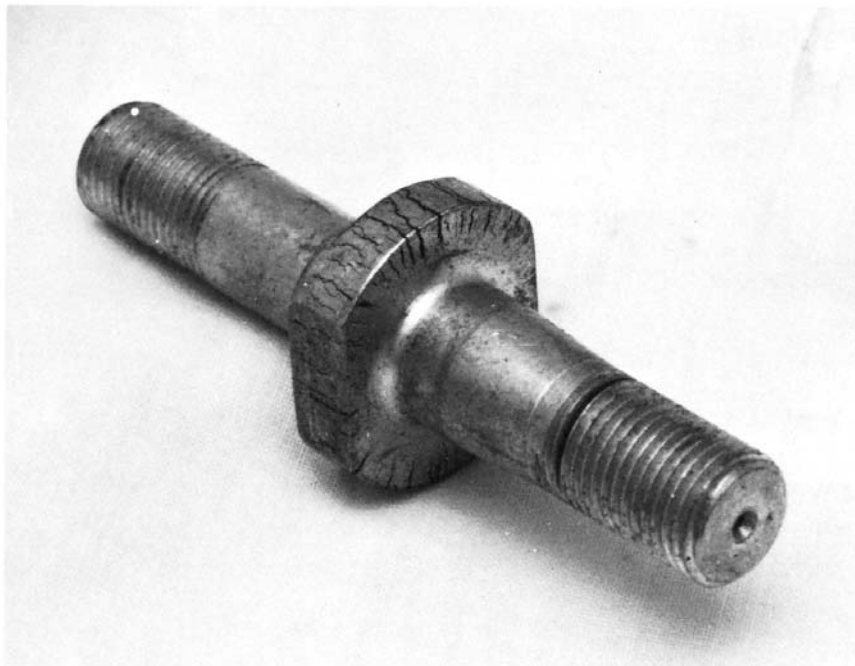

FIG. A1.8 Indications of Surface Cracking (Produced by Circular Direct Magnetization DC Continuous)

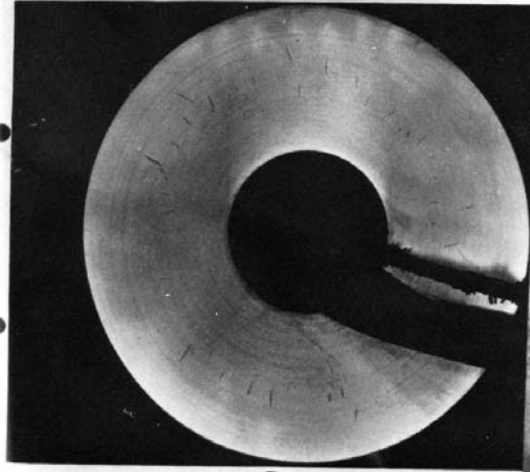

FIG. A1.9 Indications of Surface Cracks (Produced by Central Conductor Magnetization DC Continuous)

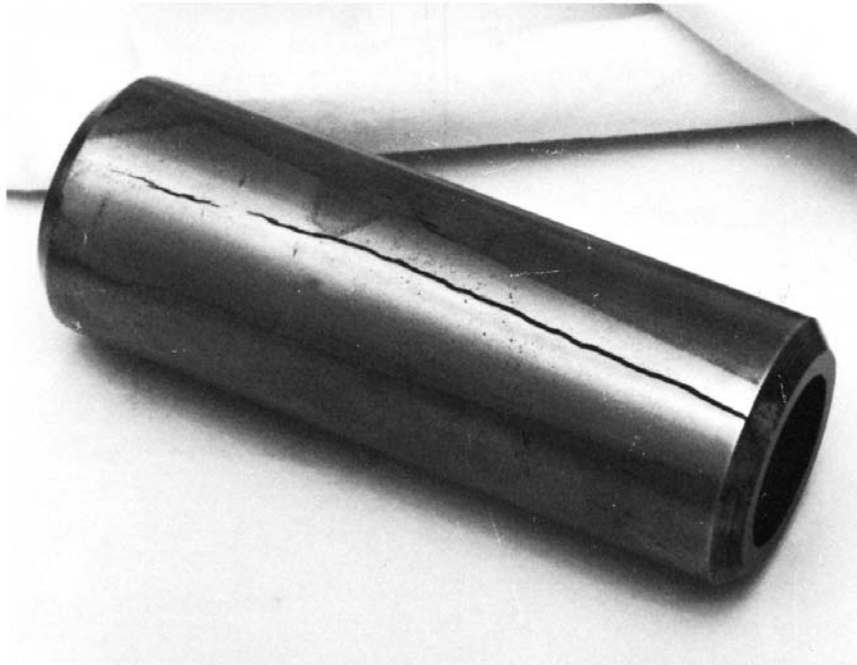

FIG. A1.10 Indications of Surface Cracks (Produced by Circular Indirect Magnetization DC)

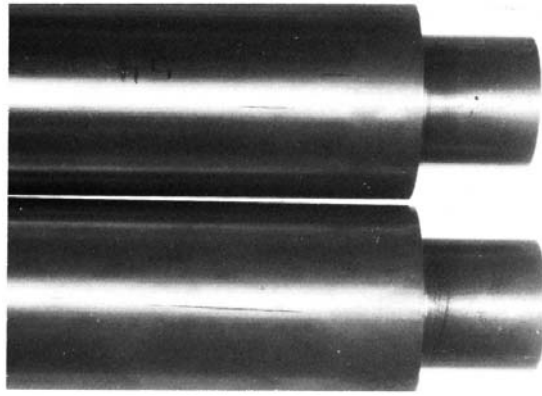

FIG. A1.11 Indications of a Near-Surface Discontinuity (Produced by Circular Direct Magnetization AC Continuous)

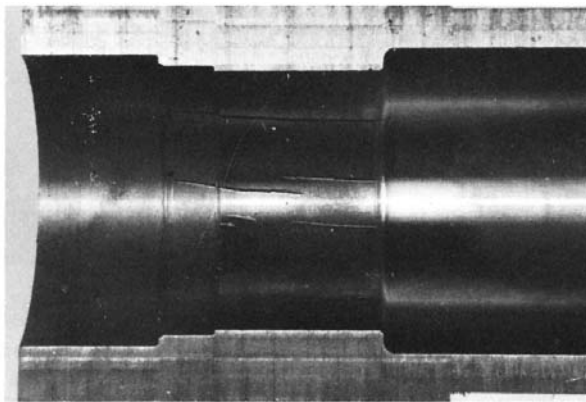

FIG. A1.12 Indications of Near-Surface Indications (Produced by Circular Direct Magnetization AC Continuous)

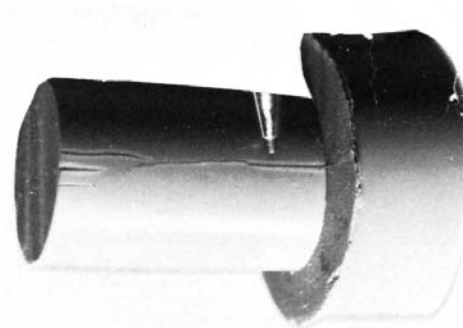

FIG. A1.13 Magnetic Rubber Indications of Surface Cracks in Aircraft Fastener Holes (Produced by Yoke Magnetization DC Continuous)

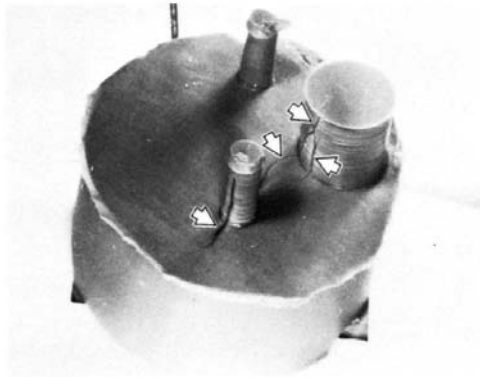

FIG. A1.14 Magnetic Rubber Indications of Surface Cracks in Aircraft Fastener Holes (Produced by Yoke Magnetization DC Continuous)

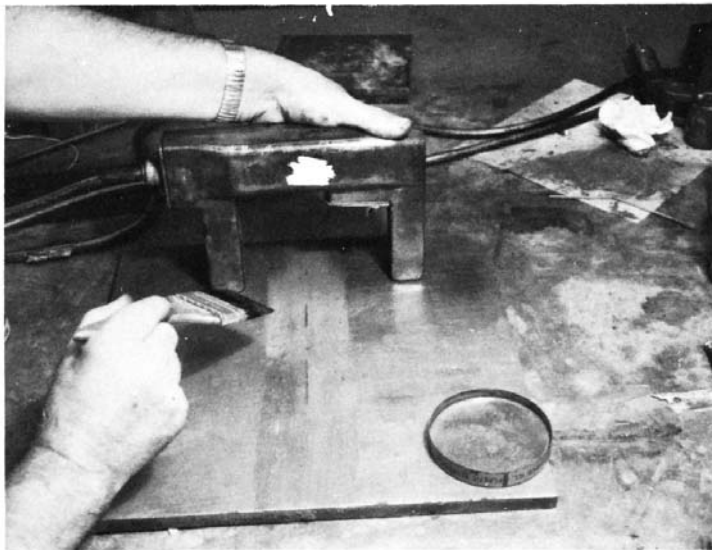

FIG. A1.15 Magnetic Slurry Indications of Surface Cracks in Weldment (Produced by Yoke Magnetization, AC Continuous)

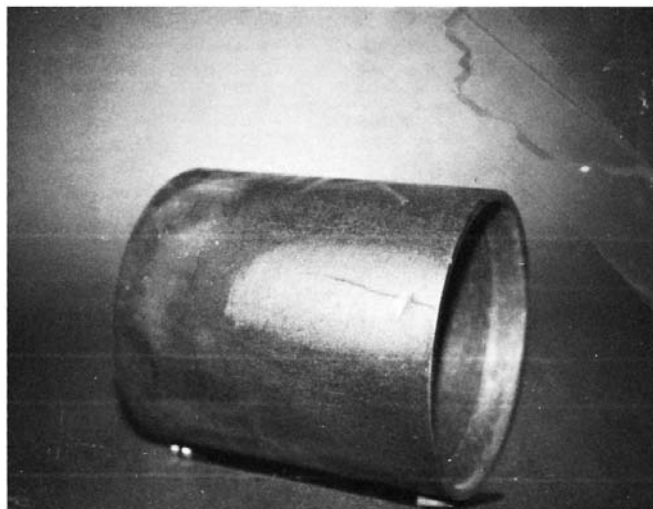

FIG. A1.16 Magnetic Slurry Indications of Surface Cracks (Produced by Yoke Magnetization, AC Continuous)



FIG. A1.17 Indications of a Near-Surface Discontinuity (Produced by Prod Magnetization, HWDC Continuous)



FIG. A1.18 Indications of a Near-Surface Discontinuity (Produced by Prod Magnetization, HWDC Continuous)

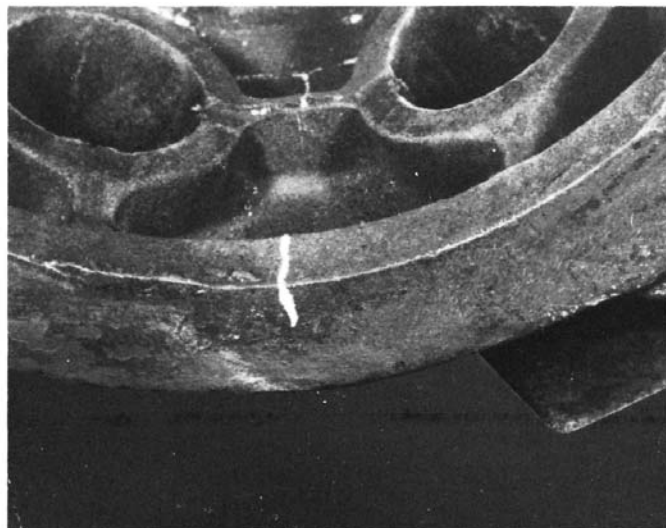

FIG. A1.19 Indication of Surface Cracks (Produced by Circular Indirect Magnetization, AC Continuous)

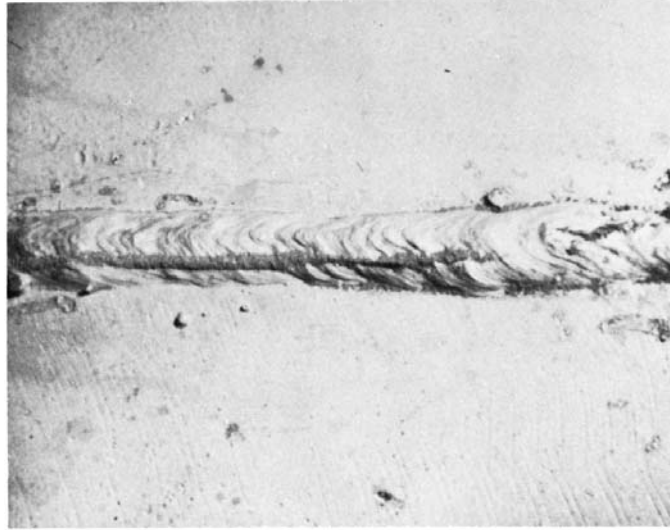

FIG. A1.20 Indication of Surface Cracks (Produced by Prod Magnetization, AC Continuous)

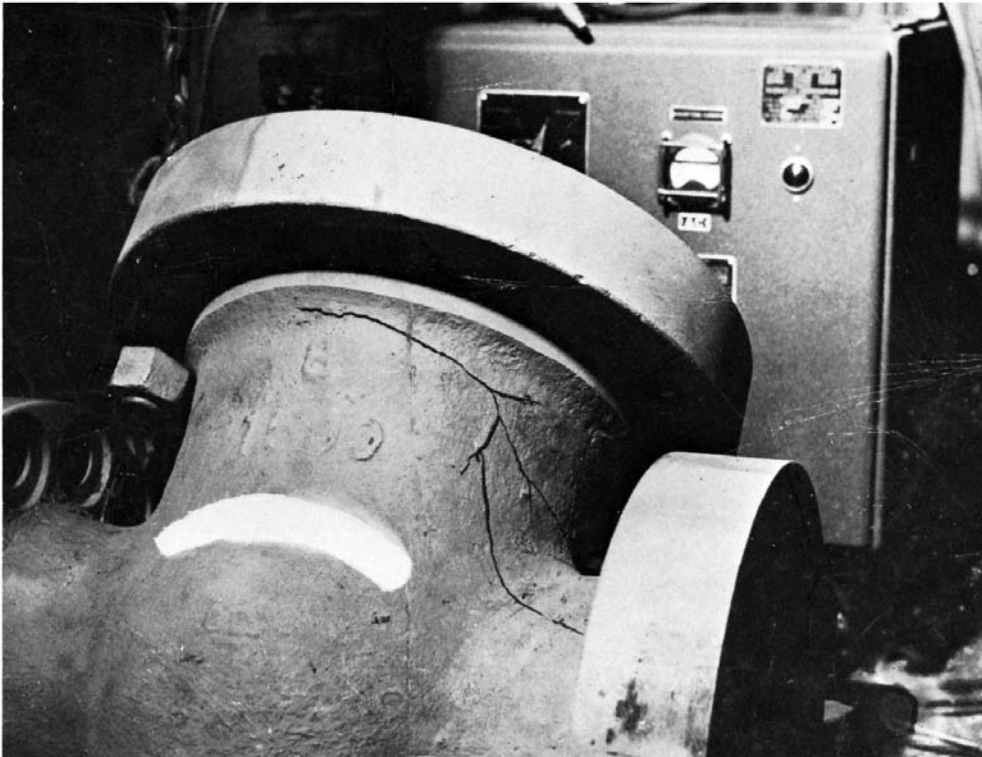

FIG. A1.21 Indications of Surface Cracks (Produced by Prod Magnetization, DC Continuous)



FIG. A1.22 Indications of Surface Cracks (Produced by Circular Direct Magnetization, AC Continuous)

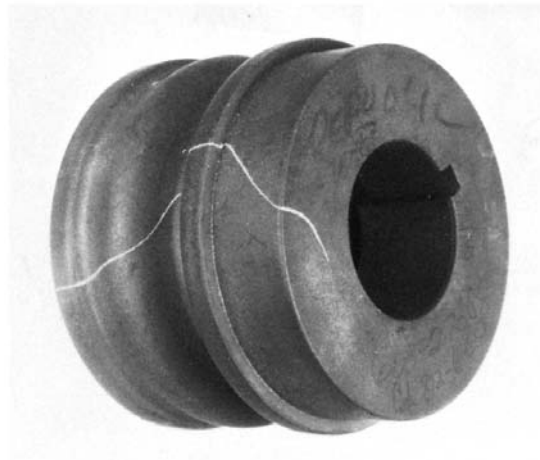

FIG. A1.23 Indications of Surface Cracks (Produced by Central Conductor Magnetization, AC Continuous)

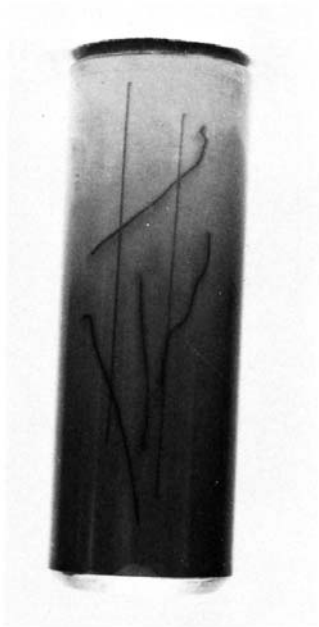

FIG. A1.24 Nonrelevant Indications of Magnetic Writing
(Produced by Direct Magnetization, DC Continuous)

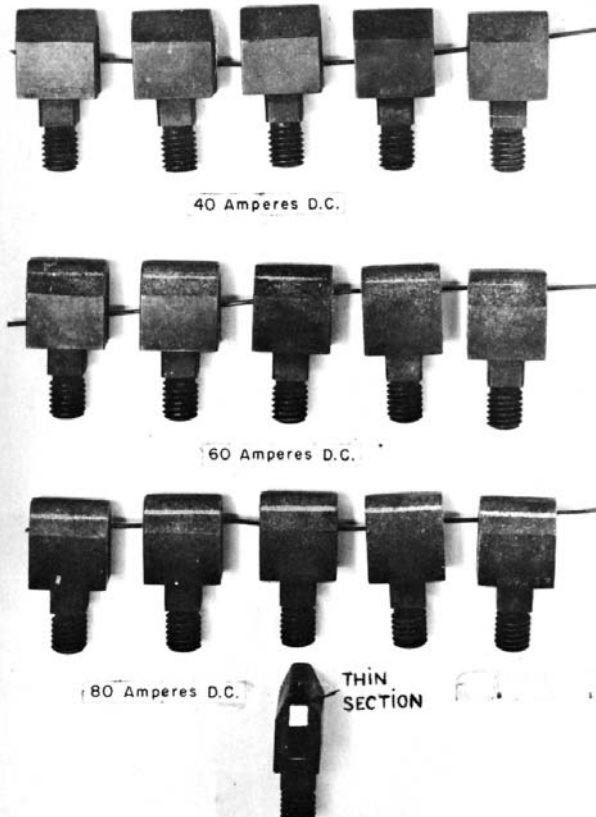

FIG. A1.25 Nonrelevant Indications Due to Change in Section on
a Small Part (Produced by Indirect, Circular Magnetization, DC
Continuous)

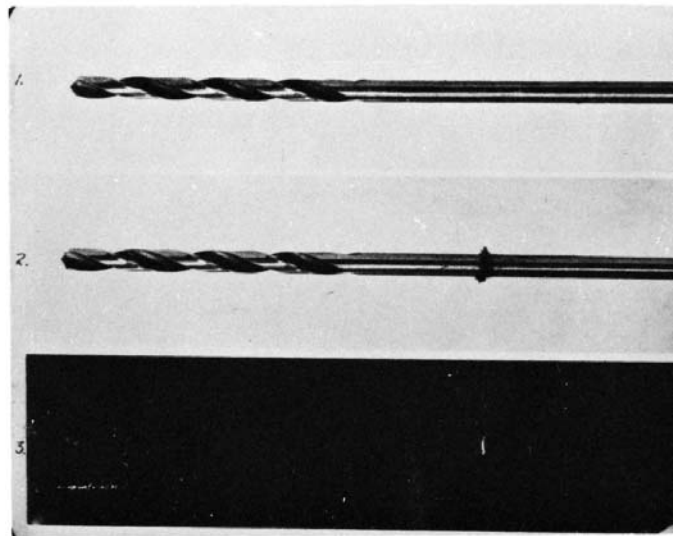

FIG. A1.26 Nonrelevant Indications of Junction Between Dissimilar Materials (Produced by Coil DC Residual Magnetization)

APPENDIXES

(Nonmandatory Information)

X1. MAGNETIZATION OF OILFIELD TUBULARS

X1.1 The following requirements should be used to induce residual magnetic fields in oilfield tubulars (tubing, casing, line pipe, and drill pipe).

X1.2 Circular Magnetism

X1.2.1 When capacitor-discharge units are used as magnetizing sources, the oilfield tubulars should be insulated from metal racks and adjacent oilfield tubulars to prevent arc burns.

X1.2.2 Partial demagnetization might occur in a magnetized length of oilfield tubulars if it is not sufficiently separated prior to magnetizing the next adjacent length. The distance used should be at least 36 inches or as determined by the formula $I(0.006)$, whichever is greater, where I is the amperage applied.

X1.2.3 For battery or three-phase rectified-AC power supplies, a minimum magnetizing current of 300 Amps/in of specified outside diameter should be used.

X1.2.4 For full circumference inspection of material with a specified outside diameter of 16 inches and smaller, centralization of the central conductor is not required during magnetization.

X1.2.5 For capacitor-discharge units, see [Table X1.1](#) for magnetizing current requirements.

X1.2.6 The above requirements have been demonstrated by empirical data and do not require verification, however, the amperage should be monitored during current application.

X1.3 Longitudinal Magnetization

X1.3.1 The number of coil turns and current required are imprecise but should not be less than 500 ampere-turns per inch of specified outside diameter. The current should be set as high as possible, but not so high as to cause furring of dry magnetic particles or immobility of wet magnetic particles.

TABLE X1.1 Capacitor Discharge Minimum Current

Number of Pulses	Capacitor Discharge Amperage Requirements	
Single	240 times specified weight per foot in lb/ft	161 times specified weight per metre in kg/m
Double	180 times specified weight per foot in lb/ft	121 times specified weight per metre in kg/m
Triple	145 times specified weight per foot in lb/ft	97 times specified weight per metre in kg/m

X2. REFERENCE STANDARD NOTCHED SHIMS FOR MAGNETIC PARTICLE TESTING IN ACCORDANCE WITH AS 5371

X2.1 The following standard flawed shims are typically used to establish proper field direction and ensure adequate field strength during technique development in magnetic particle examination. The shims of Fig. X2.1 may be used to ensure the establishment and balance of fields in the multidirectional magnetization method.

X2.1.1 The shims are available in two thicknesses, 0.002 in. (0.05 mm) and 0.004 in. (0.10 mm). Thinner shims are used when the thicker shims cannot conform to the part surface in the area of interest.

X2.1.2 The shims are available in two sizes, 0.75 in. (19 mm) square for Figs. X2.1 and X2.2 and 0.79 in. (20 mm) square for Figs. X2.3 and X2.4.

The shims of Fig. X2.3 are cut, by the user, into four 0.395 in. (10 mm) square shims for use in restricted areas.

X2.1.3 Shims should be low carbon steel, AMS 5062 or equivalent.

X2.1.4 Shims should be used as specified in AS 5371. Shims are placed in the area(s) of interest with notches toward the surface of the part being examined. Use enough shims or place the shims in multiple areas to ensure proper field directions and strengths are obtained.

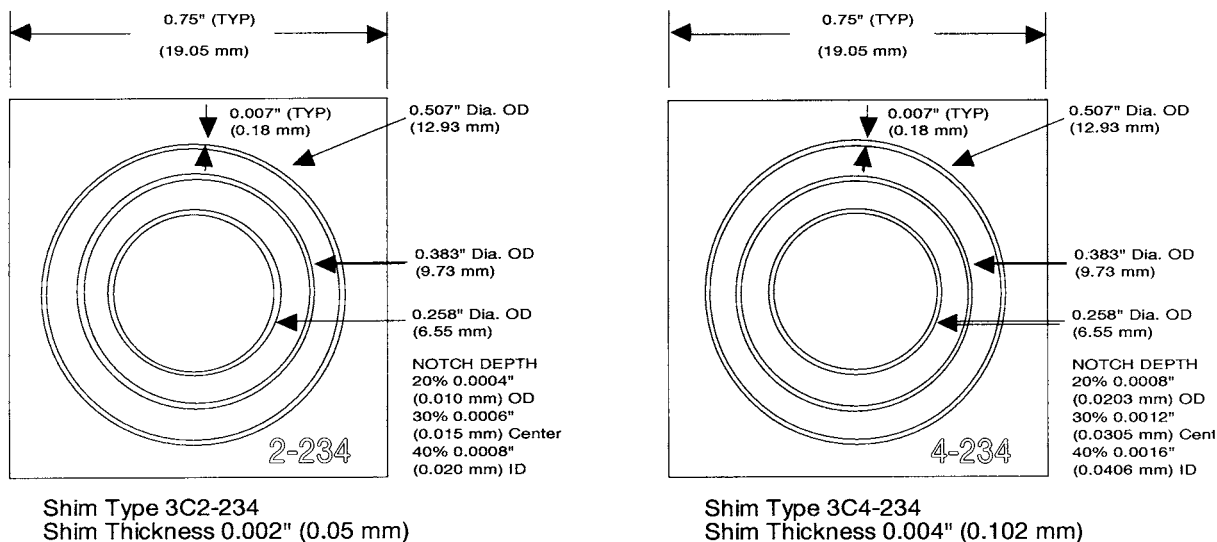

FIG. X2.1 Shim Thicknesses for Shim Types 3C2-234 and 3C4-234

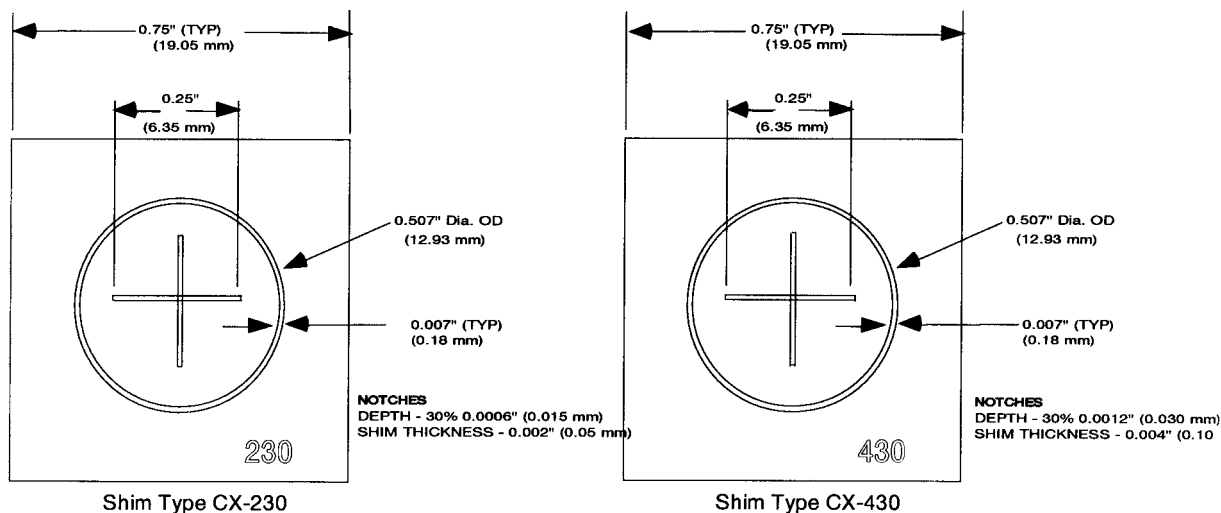

FIG. X2.2 Shim Types CX-230 and CX-430

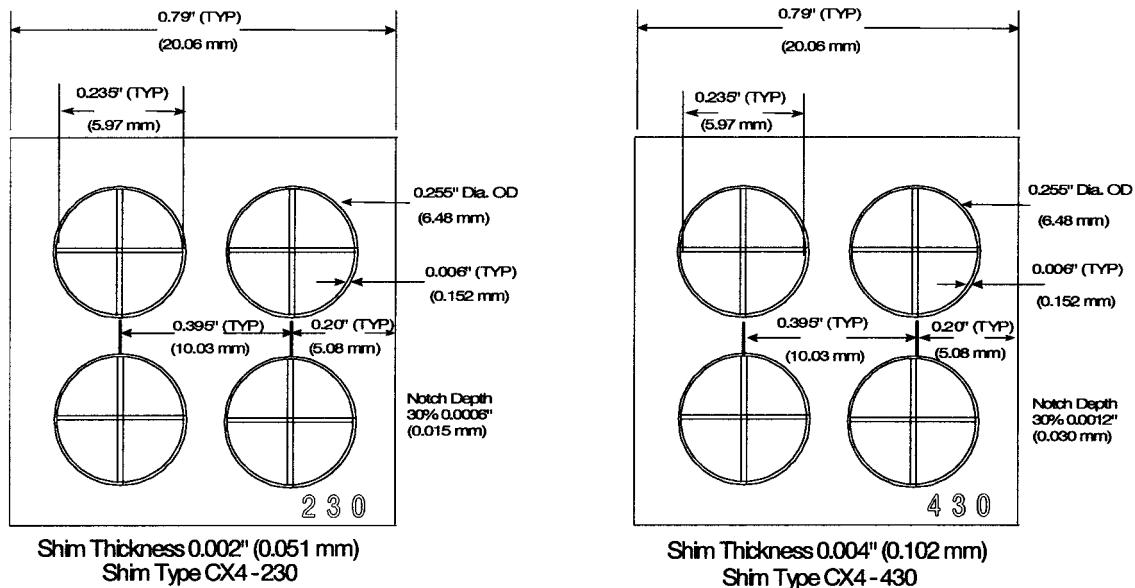

FIG. X2.3 Shim Thicknesses for Shim Types CX4-230 and CX4-430

X3. EMPIRICAL FORMULAS

X3.1 This appendix has empirical formulas for establishing magnetic field strengths; they are rules of thumb. As such, they must be used with judgment. Their use may lead to:

X3.1.1 Over magnetization, which causes excessive particle background that makes interpretation more difficult if not impossible.

X3.1.2 Poor coverage.

X3.1.3 Poor choice of examination geometries.

X3.1.4 A combination of the above.

X3.2 *Guidelines for Establishing Magnetic Fields*—The following guidelines can be effectively applied for establishing proper levels of circular and longitudinal magnetization using empirical formulas.

X3.2.1 Circular Magnetization

Magnetic Field Strength:

X3.2.1.1 Direct Circular Magnetization

When magnetizing by passing current directly through the part the nominal current should generally be 300–800 A/in. of part diameter (12 to 32 A/mm). The diameter of the part should be taken as the greatest distance between any two points on the outside circumference of the part. Currents will normally be 500 A/in. (20 A/mm) or lower, with the higher currents up to 800 A/in. (32 A/mm) being used to examine for inclusions or to examine low-permeability alloys. Amperages of less than 300 A/in. may be used when part configuration dictates and approval is obtained from the Level III and the Cognizant Engineering Organization. The field strengths generated through the use of empirical formulas should be verified with a Hall effect gaussmeter or AS 5371 shims.

X3.2.1.2 Central Conductor Induced Magnetization

When using offset central conductors the conductor passing through the inside of the part is placed against an inside wall of the part. The current should be from 12 A per mm of part diameter to 32 A per mm of part diameter (300 to 800 A/in.). The diameter of the part should be taken as the largest distance between any two points on the outside circumference of the part. Generally, currents will be 500 A/in. (20 A per mm) or lower with the higher currents (up to 800 A/in.) being used to examine for inclusions or to examine low permeability alloys such as precipitation-hardening steels. For examinations used to locate inclusions in precipitation-hardening steels even higher currents, up to 1000 A/in. (40 A per mm) may be used. The distance along the part circumference, which may be effectively examined should be taken as approximately four times the diameter of the central conductor, as illustrated in Fig. 10(b). The entire circumference should be examined by rotating the part on the conductor, allowing for approximately a 10 % magnetic field overlap. Less overlap, different current levels, and larger effective regions (up to 360°) may be used if the presence of suitable field levels is verified.

X3.2.2 Air-Core Coil Longitudinal Magnetization

Longitudinal part magnetization is produced by passing a current through a multi-turn coil encircling the part, or section of the part to be examined. A magnetic field is produced parallel to the axis of the coil. The unit of measurement is ampere turns (NI) (the actual amperage multiplied by the number of turns in the encircling coil or cable). The effective is variable and is a function of the fill factor and field extends on either side of the coil. The effective distance can easily be determined by use of a Gauss (Tesla) meter to identify where the flux lines are leaving to complete their return loop. Long parts should be examined in sections that do not exceed this length. There are four empirical longitudinal magnetization formulas employed for using encircling coils, the formula to be used depending on the fill factor. The formulas are included for historical continuity only. If used its use should be limited to simple shaped parts. It would be quicker and more accurate to use a Gauss (Tesla) meter, lay its probe on the part and measure the field rather than to calculate using the formulas.

X3.2.2.1 Low Fill-Factor Coils

In this case, the cross-sectional area of the fixed encircling coil greatly exceeds the cross-sectional area of the part (less than 10 % coil inside diameter). For proper part magnetization, such parts should be placed well within the coils and close to the inside wall of the coil. With this low fill-factor, adequate field strength for eccentrically positioned parts with a length-over-diameter ratio (L/D) between 3 and 15 is calculated from the following equations:⁹

(1) *Parts with Low Fill-Factor Positioned Close to Inside Wall of Coil:*

$$NI = K(L/D) (\pm 10 \%) \quad (X3.1)$$

where:

- N = number of turns in the coil,
- I = coil current to be used, amperes (A),
- K = 45 000 (empirically derived constant),
- L = part, length, in., (see Note),
- D = part diameter, in.; for hollow parts, see X3.2.2.4, and
- NI = ampere turns.

For example, a part 15 in. (38.1 cm) long with 5-in. (12.7-cm) outside diameter has an L/D ratio of 15/5 or 3. Accordingly, the ampere turn requirement ($NI = 45\,000/3$) to provide adequate field strength in the part would be 15 000 ampere turns. If a five-turn coil or cable is used, the coil amperage requirements would be ($I = 15\,000/5$) = 3000 A ($\pm 10 \%$). A500 turn coil would require 30 A ($\pm 10 \%$).

(2) *Parts with a Low Fill-Factor Positioned in the Center of the Coil:*

$$NI = KR/\{(6L/D) - 5\}(\pm 10 \%) \quad (X3.2)$$

where:

- N = number of turns in the coil,
- I = coil current to be used, A,
- K = 43 000 (empirically derived constant),
- R = coil radius, in.,
- L = part length, in. (see Note),
- D = part diameter, in., for hollow parts (see X3.2.2.4), and
- NI = ampere turns.

For example, a part 15 in. (38.1 cm) long with 5-in. (12.7-cm) outside diameter has a L/D ratio of 15/5 or 3. If a five-turn 12-in. diameter (6-in. radius) (30.8-cm diameter (15.4-cm radius)) coil or cable is used, (I) the ampere turns requirement would be as follows:

$$NI = \frac{(43\,000 \times 6)}{((6 \times 3) - 5)} \text{ or } 19\,846$$

and (2) the coil amperage requirement would be as follows:

$$\frac{19\,846}{5} \text{ or } 3\,969 \text{ A } (\pm 10 \%)$$

X3.2.2.2 Intermediate Fill-Factor Coils

When the cross section of the coil is greater than twice and less than ten times the cross section of the part being examined:

$$NI = (NI)_{hf}(10 - Y) + (NI)_{lf}(Y - 2)/8 \quad (X3.3)$$

where:

- NI_{hf} = value of NI calculated for high fill-factor coils using Eq X3.3,
- NI_{lf} = value of NI calculated for low fill-factor coils using Eq X3.1 or Eq X3.2, and
- Y = ratio of the cross-sectional area of the coil to the cross section of the part. For example, if the coil has an inside diameter of 10 in. (25.4 cm) and part (a bar) has an outside diameter of 5 in. (12.2 cm)

$$Y = (\pi(5)^2)/(\pi(2.5)^2) = 4$$

X3.2.2.3 High Fill-Factor Coils

⁹ These equations are included for historical continuity only. It is faster to buy a Tesla meter, lay the probe on the part and measure the field strength than calculating using the equations.

In this case, when fixed coils or cable wraps are used and the cross-sectional area of the coil is less than twice the cross-sectional area (including hollow portions) of the part, the coil has a high fill-factor.

(I) For Parts Within a High Fill-Factor Positioned Coil and for Parts with an L/D ratio equal to or greater than 3:

$$NI = \frac{K}{\{(L/D) + 2\}} (\pm 10 \%)$$

where:

- N = number of turns in the coil or cable wrap,
- I = coil current, A,
- K = 35 000 (empirically derived constant),
- L = part length, in.,
- D = part diameter, in., and
- NI = ampere turns.

For example, the application of Eq X3.3 can be illustrated as follows: a part 10 in. (25.4 cm) long-with 2-in. (5.08-cm) outside diameter would have an L/D ratio of 5 and an ampere turn requirements of $NI = 35\,000/(5 + 2)$ or 5000 ($\pm 10 \%$) ampere turns. If a five-turn coil or cable wrap is employed, the amperage requirement is 5000/5 or 1000 A ($\pm 10 \%$).

X4. DEVICES FOR EVALUATION OF MAGNETIC PARTICLE EXAMINATION MATERIALS

X4.1 Scope

X4.1.1 The purpose of this appendix is to describe the capabilities and use of various devices that may be utilized to monitor and evaluate the performance of materials and systems for magnetic particle examination.

X4.2 Magnetic Stripe Cards. The magnetically encoded pattern in magnetic stripes, as on cards used for personal banking, identification and other purposes, can serve as a tool to evaluate magnetic particle examination materials. Particles are attracted to the magnetic gradients formed in the stripe when the stripe has been magnetically encoded with a pattern of flux reversals. The encoding of the stripe can be controlled to provide gradients of varying magnitude. Particles can be evaluated for sensitivity when observed to see how small a gradient can generate a particle indication.

X4.3 Characteristics

X4.3.1 Magnetic stripe cards should be made in accordance with ISO 7810– Identification Cards— Physical Characteristics.

X4.3.2 The stripe may be made of either low-coercivity (lo-co) or high-coercivity (hi-co) material, as designated by the manufacturer.

X4.3.3 A constant encoding pattern, decaying encoding pattern, reverse decaying pattern or other pattern may be encoded into the stripe. See Fig. X4.1 photograph of fluorescent particle indications of decaying and reverse decaying encoding patterns.

NOTE X3.1—For L/D ratios less than 3, a pole piece (ferromagnetic material approximately the same diameter as part) should be used to effectively increase the L/D ratio or utilize an alternative magnetization method such as induced current. For L/D ratios greater than 15, a maximum L/D value of 15 should be used for all formulas cited above.

X3.2.2.4 L/D Ratio for a Hollow Piece

When calculating the L/D ratio for a hollow piece, D should be replaced with an effective diameter D_{eff} calculated using:

$$D_{\text{eff}} = 2[(A_t - A_h)/\pi]^{1/2}$$

where:

- A_t = total cross-sectional area of the part, and
- A_h = cross-sectional area of the hollow portion(s) of the part.

$$D_{\text{eff}} = [(OD)^2 - (ID)^2]^{1/2}$$

where:

- OD = outside diameter of the cylinder, and
- ID = inside diameter of the cylinder.

X4.4 Use of the Magnetic Stripe Card for Magnetic Particle Material Evaluation

X4.4.1 *Wet Method Materials*—Wet method materials may be poured, sprayed or otherwise applied to the stripe, as they would be used for MPI. Excess bath should be allowed to flow away from the stripe. The stripe should be observed under suitable illumination (See Section 7) for the formation of particle indications. Observations should be noted as to the quantity of particle indications and the clarity thereof.

NOTE X4.1—Dark colored non-fluorescent particles may be more readily observed with the use of a white contrast paint applied over the stripe prior to particle evaluation. Particle indications may also be observed and/or permanently recorded per Section 17 (Paragraph 17.1.2 can apply to wet method powder after the fluid has been allowed to evaporate.).

X4.4.2 *Dry Method Materials*—Dry method materials should be poured, dusted, blown or otherwise applied to the stripe, as they would be used for MPI. Excess powder should be removed with a gentle blowing action. The stripe should be observed under suitable illumination (See Section 7) for the formation of particle indications. Observations should be noted as to the quantity of particle indications and the clarity thereof.

X4.4.3 *Recording of Indications*—Recorded particle indications (See 17.1.2) may serve as material documentation records and standards for material performance. Other material, or the same material at a later time, can be compared at any time to the recorded standard.

X4.5 *Loss of Indications on the Stripe*—There are several circumstances where particle indications may not be visible on

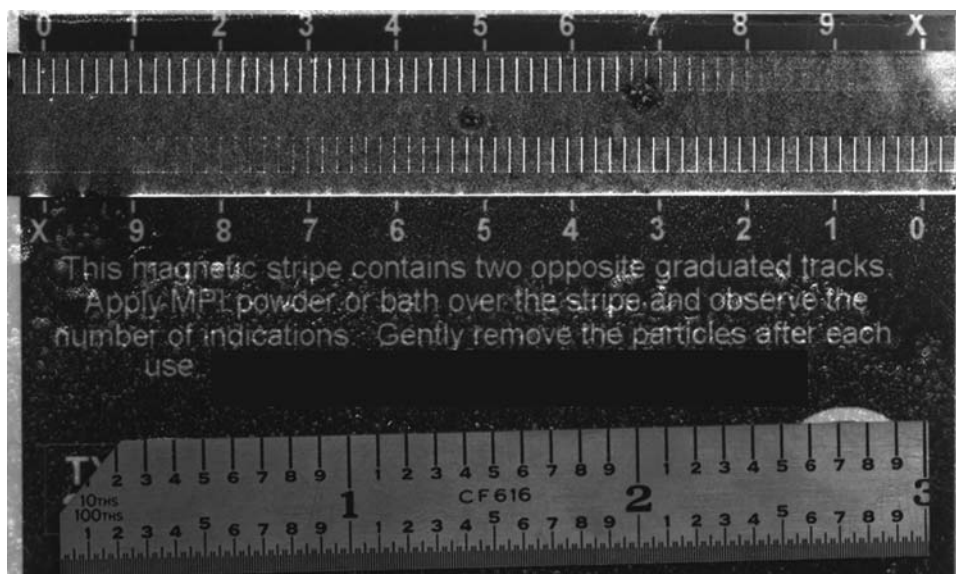

FIG. X4.1 Example of fluorescent particle indications of a decaying encoding pattern (top track) and a reverse-decaying pattern (bottom track) on the magnetic stripe of a magnetic stripe card.

the magnetic stripe. When indications are not visible the subject particles should not be used for examination unless otherwise verified as being acceptable.

X4.5.1 *Concentration*—The subject wet method particles may not have a sufficient level of concentration. In this case, increase the concentration level of the bath and re-perform the check until the particles demonstrate suitable performance.

X4.5.2 *Sensitivity*—The subject particles may not provide necessary sensitivity. In this case, replace the material with a suitably sensitive material and re-perform the check until the particles demonstrate suitable performance.

X4.5.3 *Erasure*—The stripe has become magnetically erased. In this case, no discernible particle indication will appear. In this case, repeat the check with another card and/or sensitivity check until the particles demonstrate suitable performance.

performance. Either destroy the card with the de-encoded stripe or report it to the manufacturer and follow the manufacturer’s recommendations.

X4.6 Precautions

X4.6.1 *Preparation*—The surface of the stripe must be clean of any fluid or foreign matter prior to the application of the MPI material. The encoded stripe should not be re-magnetized in any manner prior to use or de-magnetized in any manner following its use.

X4.6.2 *Storage*—The surface of the stripe should be cleaned of remaining fluid and particles after the observations of the MPI material have been made. When not in use, the card should be stored away from excessive heat and strong magnetic fields.

X5. CENTRIFUGE TUBES

X5.1 Centrifuge tubes should be pear-shaped, made from thoroughly annealed glass, and conform to the dimensions

given in Figs. X5.1 and X5.2 as applicable. The graduations, numbered as shown, should be clear and distinct.

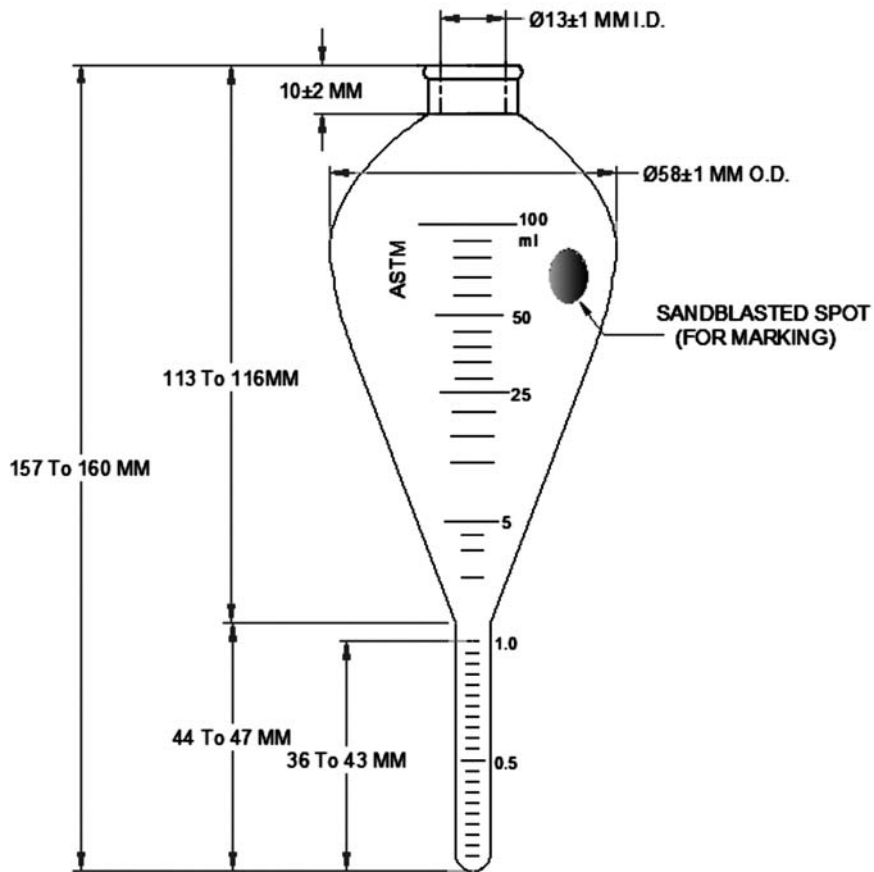

FIG. X5.1 Pear Shaped Centrifuge Tube – Fluorescent Bath

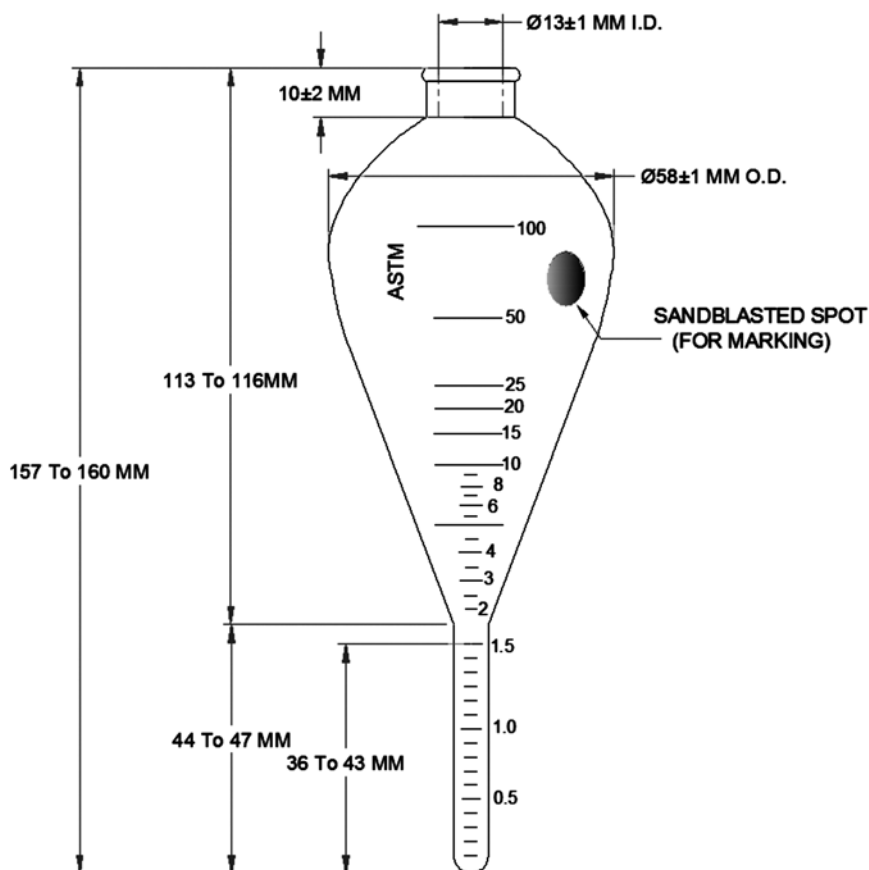

FIG. X5.2 Pear Shaped Centrifuge Tube – Non-Fluorescent Bath

ASTM International takes no position respecting the validity of any patent rights asserted in connection with any item mentioned in this standard. Users of this standard are expressly advised that determination of the validity of any such patent rights, and the risk of infringement of such rights, are entirely their own responsibility.

This standard is subject to revision at any time by the responsible technical committee and must be reviewed every five years and if not revised, either reapproved or withdrawn. Your comments are invited either for revision of this standard or for additional standards and should be addressed to ASTM International Headquarters. Your comments will receive careful consideration at a meeting of the responsible technical committee, which you may attend. If you feel that your comments have not received a fair hearing you should make your views known to the ASTM Committee on Standards, at the address shown below.

This standard is copyrighted by ASTM International, 100 Barr Harbor Drive, PO Box C700, West Conshohocken, PA 19428-2959, United States. Individual reprints (single or multiple copies) of this standard may be obtained by contacting ASTM at the above address or at 610-832-9585 (phone), 610-832-9555 (fax), or service@astm.org (e-mail); or through the ASTM website (www.astm.org).