

ASME B30.21-2014
[Revision of B30.21-2005 (R2010)]

Lever Hoists

**Safety Standard for Cableways,
Cranes, Derricks, Hoists, Hooks,
Jacks, and Slings**

AN AMERICAN NATIONAL STANDARD



**The American Society of
Mechanical Engineers**

INTENTIONALLY LEFT BLANK

ASME B30.21-2014
[Revision of ASME B30.21-2005 (R2010)]

Lever Hoists

**Safety Standard for Cableways,
Cranes, Derricks, Hoists, Hooks,
Jacks, and Slings**

AN AMERICAN NATIONAL STANDARD



**The American Society of
Mechanical Engineers**

Two Park Avenue • New York, NY • 10016 USA

Date of Issuance: May 30, 2014

The next edition of this Standard is scheduled for publication in 2019. This Standard will become effective 1 year after the Date of Issuance.

ASME issues written replies to inquiries concerning interpretations of technical aspects of this Standard. Interpretations are published on the ASME Web site under the Committee Pages at <http://cstools.asme.org/> as they are issued. Interpretations will also be included with each edition.

Errata to codes and standards may be posted on the ASME Web site under the Committee Pages to provide corrections to incorrectly published items, or to correct typographical or grammatical errors in codes and standards. Such errata shall be used on the date posted.

The Committee Pages can be found at <http://cstools.asme.org/>. There is an option available to automatically receive an e-mail notification when errata are posted to a particular code or standard. This option can be found on the appropriate Committee Page after selecting “Errata” in the “Publication Information” section.

ASME is the registered trademark of The American Society of Mechanical Engineers.

This code or standard was developed under procedures accredited as meeting the criteria for American National Standards. The Standards Committee that approved the code or standard was balanced to assure that individuals from competent and concerned interests have had an opportunity to participate. The proposed code or standard was made available for public review and comment that provides an opportunity for additional public input from industry, academia, regulatory agencies, and the public-at-large.

ASME does not “approve,” “rate,” or “endorse” any item, construction, proprietary device, or activity.

ASME does not take any position with respect to the validity of any patent rights asserted in connection with any items mentioned in this document, and does not undertake to insure anyone utilizing a standard against liability for infringement of any applicable letters patent, nor assume any such liability. Users of a code or standard are expressly advised that determination of the validity of any such patent rights, and the risk of infringement of such rights, is entirely their own responsibility.

Participation by federal agency representative(s) or person(s) affiliated with industry is not to be interpreted as government or industry endorsement of this code or standard.

ASME accepts responsibility for only those interpretations of this document issued in accordance with the established ASME procedures and policies, which precludes the issuance of interpretations by individuals.

No part of this document may be reproduced in any form,
in an electronic retrieval system or otherwise,
without the prior written permission of the publisher.

The American Society of Mechanical Engineers
Two Park Avenue, New York, NY 10016-5990

Copyright © 2014 by
THE AMERICAN SOCIETY OF MECHANICAL ENGINEERS
All rights reserved
Printed in U.S.A.

CONTENTS

Foreword	iv
Committee Roster	vi
B30 Standard Introduction	viii
Summary of Changes	xi
Chapter 21-0 Scope, Definitions, Personnel Competence, and References	1
Section 21-0.1 Scope of ASME B30.21	1
Section 21-0.2 Definitions	1
Section 21-0.3 Personnel Competence	7
Section 21-0.4 References	7
Chapter 21-1 Construction and Installation	8
Section 21-1.1 Marking	8
Section 21-1.2 Construction	8
Section 21-1.3 Translation	10
Chapter 21-2 Inspection and Testing	11
Section 21-2.1 Inspection	11
Section 21-2.2 Lifting Load Chain, Rope, or Web Strap Inspection	14
Section 21-2.3 Testing	15
Chapter 21-3 Operation and Operator Training	16
Section 21-3.1 Training	16
Section 21-3.2 Hoisting Practices for Operators	16
Chapter 21-4 Maintenance and Maintenance Training	18
Section 21-4.1 Training	18
Section 21-4.2 Maintenance	18
Section 21-4.3 Welded Link Chain Replacement and Maintenance	18
Section 21-4.4 Roller and Rollerless Chain Replacement and Maintenance	19
Section 21-4.5 Rope Replacement and Maintenance	19
Section 21-4.6 Web Strap Replacement and Maintenance	20
Figures	
21-0.1-1 Lever Hoist — Chain Type	2
21-0.1-2 Lever Hoist — Rope	3
21-0.1-3 Lever Hoist — Web Strap	3
21-0.2-1 Lever Hoist — Chain Type	4
21-0.2-2 Load Chain	5
21-0.2-3 Guide and Load Sprocket-Strap	5
21-0.2-4 Load Controlling Mechanism	6
21-0.2-5 Overtravel Restraint	6
21-0.2-6 Load Sprockets	7
21-1.2.6-1 Swivel Type Hook	9
Tables	
21-2.1.4-1 Minimum Frequent Inspection for Lever Hoists	12
21-2.1.5-1 Minimum Periodic Inspection for Lever Hoists	13

FOREWORD

This American National Standard, Safety Standard for Cableways, Cranes, Derricks, Hoists, Hooks, Jacks, and Slings, has been developed under the procedures accredited by the American National Standards Institute (ANSI). This Standard had its beginning in December 1916, when an eight-page "Code of Safety Standards for Cranes," prepared by an ASME Committee on the Protection of Industrial Workers, was presented at the annual meeting of ASME.

Meetings and discussions regarding safety on cranes, derricks, and hoists were held from 1920 to 1925, involving the ASME Safety Code Correlating Committee, the Association of Iron and Steel Electrical Engineers, the American Museum of Safety, the American Engineering Standards Committee (AESC) [later changed to American Standards Association (ASA), then to the United States of America Institute (USASI), and finally to ANSI], Department of Labor — State of New Jersey, Department of Labor and Industry — State of Pennsylvania, and the Locomotive Crane Manufacturers Association. On June 11, 1925, AESC approved the ASME Safety Code Correlating Committee's recommendation and authorized the project with the U.S. Department of the Navy, Bureau of Yards and Docks, and ASME as sponsors.

In March 1926, invitations were issued to 50 organizations to appoint representatives to a Sectional Committee. The call for organization of this Sectional Committee was sent out October 2, 1926, and the committee organized November 4, 1926, with 57 members representing 29 national organizations. Commencing June 1, 1927, and using the eight-page code published by ASME in 1916 as a basis, the Sectional Committee developed the "Safety Code for Cranes, Derricks, and Hoists." The early drafts of this safety code included requirements for jacks but due to inputs and comments on those drafts, the Sectional Committee decided in 1938 to make the requirements for jacks a separate code. In January 1943, ASA B30.2-1943 was published addressing a multitude of equipment types and in August 1943, ASA B30.1-1943 was published just addressing jacks. Both documents were reaffirmed in 1952 and widely accepted as safety standards.

Due to changes in design, advancement in techniques, and general interest of labor and industry in safety, the Sectional Committee, under the joint sponsorship of ASME and the Bureau of Yards and Docks (now the Naval Facilities Engineering Command), was reorganized on January 31, 1962, with 39 members representing 27 national organizations. The new committee changed the format of ASA B30.2-1943 so that the multitude of equipment types it addressed could be published in separate volumes that could completely cover the construction, installation, inspection, testing, maintenance, and operation of each type of equipment that was included in the scope of ASA B30.2. This format change resulted in the initial publication of B30.3, B30.5, B30.6, B30.11, and B30.16 being designated as revisions of B30.2 with the remainder of the B30 volumes being published as totally new volumes. ASA changed its name to USASI in 1966 and to ANSI in 1969, which resulted in B30 volumes from 1943 to 1968 being designated as ASA B30, USAS B30, or ANSI B30, depending on their date of publication.

In 1982, the Committee was reorganized as an Accredited Organization Committee, operating under procedures developed by the ASME and accredited by ANSI. This Standard presents a coordinated set of rules that may serve as a guide to government and other regulatory bodies and municipal authorities responsible for the guarding and inspection of the equipment falling within its scope. The suggestions leading to accident prevention are given both as mandatory and advisory provisions; compliance with both types may be required by employers of their employees.

In case of practical difficulties, new developments, or unnecessary hardship, the administrative or regulatory authority may grant variances from the literal requirements or permit the use of other devices or methods, but only when it is clearly evident that an equivalent degree of protection is thereby secured. To secure uniform application and interpretation of this Standard, administrative or regulatory authorities are urged to consult the B30 Committee in accordance

with the format described in Section IX of the Introduction before rendering decisions on disputed points.

Safety codes and standards are intended to enhance public safety. Revisions result from committee consideration of factors such as technological advances, new data, and changing environmental and industry needs. Revisions do not imply that previous editions were inadequate.

The first edition of ASME B30.21 was issued in 1989; new editions were published in 1994, 1999, and 2005. This edition no longer covers one product line per chapter and has adopted the more traditional B30 five-chapter format with one Chapter each for scope, definitions, references, personnel competence and references; construction and installation; inspection and testing; operation and operator training; and finally maintenance and maintenance training. In addition, this edition addresses personnel competence, translations, and responsibilities.

This edition of the B30.21 Volume was approved by the B30 Committee and by ASME, and was approved by ANSI and designated as an American National Standard on January 27, 2014.

ASME B30 COMMITTEE

Safety Standard for Cableways, Cranes, Derricks, Hoists, Hooks, Jacks, and Slings

(The following is the roster of the Committee at the time of approval of this Standard.)

STANDARDS COMMITTEE OFFICERS

L. D. Means, *Chair*
R. M. Parnell, *Vice Chair*
K. M. Hyam, *Secretary*

STANDARDS COMMITTEE PERSONNEL

N. E. Andrew, ThyssenKrupp Steel USA, LLC
C. M. Robison, *Alternate*, UT-Battelle/Oak Ridge National Laboratory
G. Austin, Terex Corp.
T. L. Blanton, NACB Group, Inc.
R. O. Ohman, *Alternate*, Trainer
P. A. Boeckman, The Crosby Group, Inc.
C. E. Lucas, *Alternate*, The Crosby Group, Inc.
R. J. Bolen, Consultant
C. E. Cotton, *Alternate*, Navy Crane Center
M. E. Brunet, Manitowoc Cranes/The Manitowoc Crane Group
A. L. Calta, *Alternate*, Manitowoc Crane Group
T. A. Christensen, Liberty Mutual Group
M. W. Mills, *Alternate*, Liberty Mutual Group
B. Closson, Craft Forensic Service
B. A. Pickett, *Alternate*, Forensic Engineering and Applied Science Institute
R. M. Cutshall, Savannah River Nuclear Solutions
J. A. Danielson, The Boeing Co.
P. W. Boyd, *Alternate*, The Boeing Co.
L. D. Demark, Sr., Equipment Training Solutions, LLC
D. F. Jordan, *Alternate*, BP America
D. Eckstine, Eckstine & Associates
H. G. Leidich, *Alternate*, Leidich Consulting Services, Inc.
R. J. Edwards, NBIS
A. J. Egging, National Oilwell Varco
C. W. Ireland, *Alternate*, Consultant, National Oilwell Varco
E. D. Fidler, The Manitowoc Co., Inc.
G. D. Miller, *Alternate*, Manitowoc Cranes
J. A. Gilbert, Associated Wire Rope Fabricators
J. L. Gordon, Acco Chain & Lifting Products
N. C. Hargreaves, Terex Hargreaves Consulting, LLC
C. E. Imerman, *Alternate*, Link-Belt Construction Equipment Co.
G. B. Hetherston, E. I. DuPont
J. B. Greenwood, *Alternate*, Navy Crane Center
K. M. Hyam, The American Society of Mechanical Engineers
M. M. Jaxtheimer, Navy Crane Center
S. R. Gridley, *Alternate*, Navy Crane Center
P. R. Juhren, Morrow Equipment Co., LLC
M. J. Quinn, *Alternate*, Morrow Equipment Co., LLC
R. M. Kohner, Landmark Engineering Service
D. Duerr, *Alternate*, 2DM Associates, Inc.
A. J. Lusi, Jr., Lumark Consulting LLP
K. J. Shinn, *Alternate*, K. J. Shinn, Inc.
E. K. Marburg, Columbus McKinnon Corp.
J. R. Burkey, *Alternate*, Columbus McKinnon Corp.
L. D. Means, Means Engineering & Consulting
D. A. Henninger, *Alternate*, Bridon American
D. L. Morgan, Mission Support Alliance
T. Mackey, *Alternate*, WRPS Hanford & URS Co.
W. E. Osborn, Ingersoll Rand
S. D. Wood, *Alternate*, Link-Belt Construction Equipment Co.
G. L. Owens, Consultant
R. M. Parnell, ITI, Field Services Division
W. C. Dickinson, Jr., *Alternate*, Crane Industry Services, LLC
J. T. Perkins, Consultant
J. R. Schober, *Alternate*, American Bridge Co.
J. E. Richardson, U.S. Department of The Navy
K. Kennedy, *Alternate*, Navy Crane Center
D. W. Ritchie, Dave Ritchie Consultant, LLC
L. K. Shapiro, *Alternate*, Howard I. Shapiro & Associates
J. W. Rowland III, Consultant
D. A. Moore, *Alternate*, Unified Engineering
J. C. Ryan, Boh Bros Construction Co.
A. R. Ruud, *Alternate*, Atkinson Construction
D. W. Smith, STI Group
S. K. Rammelsberg, *Alternate*, CB&I
W. J. Smith, Jr., Nations Builder Insurance Service
J. Schoppert, *Alternate*, NBIS Claims & Risk Management
R. S. Stemp, Lampson International, LLC
E. P. Vliet, *Alternate*, Turner Industries Group
R. G. Strain, Advanced Crane Technologies, LLC
J. Sturm, Sturm Corp.
P. D. Sweeney, General Dynamics Electric Boat
B. M. Casey, *Alternate*, General Dynamics Electric Boat
J. D. Wiethorn, Haag Engineering Co.
R. C. Wild, USACE Army Engineering District
E. B. Stewart, *Alternate*, U.S. Army Corps of Engineers
D. N. Wolff, National Crane/Manitowoc Crane Group
J. A. Pilgrim, *Alternate*, Manitowoc Crane

HONORARY MEMBERS

J. W. Downs, Jr., Downs Crane and Hoist Co.
J. J. Franks, Consultant
J. M. Klibert, Lift-All Co., Inc.
R. W. Parry, Consultant
P. S. Zorich, RZP Limited

B30.21 SUBCOMMITTEE PERSONNEL

J. A. Danielson, *Chair*, The Boeing Co.
R. M. Cutshall, Savannah River Nuclear Solutions
C. K. Hale, Columbus McKinnon Corp.
C. Hess, Harrington Hoists, Inc.
H. G. Leidich, Leidich Consulting Services, Inc.

E. K. Marburg, Columbus McKinnon Corp.
J. T. Perkins, Consultant
B. A. Pickett, Forensic Engineering and Applied Science Institute
C. M. Robison, UT-Battelle/Oak Ridge National Laboratory

B30 INTEREST REVIEW GROUP

P. W. Boyd, The Boeing Co.
M. J. Eggenberger, Bay Ltd.
H. A. Hashem, Saudi Aramco
J. Hui, School of Civil Engineering, People's Republic of China
A. Mattoli, Prowinch, LLC

M. W. Osborne, E-Crane International USA
A. G. Rocha, Belgo Bekaert Arames
W. Rumburg, Crane Consultants, Inc.
C.-C. Tsaor, Institute of Occupational Safety on Health, Taiwan

B30 REGULATORY AUTHORITY COUNCIL

C. Shelhamer, *Chair*, New York City Department of Buildings
L. G. Champion, U.S. Department of Labor/OSHA
W. J. Dougherty, Jr., City of Philadelphia
C. Harris, City of Chicago — Department of Buildings
K. M. Hyam, The American Society of Mechanical Engineers

D. G. Merriman, New York State Department of Labor, Division of Safety & Health/PESH
C. R. Smith, Pennsylvania Department of State, Bureau of Professional and Occupational Affairs

SAFETY STANDARD FOR CABLEWAYS, CRANES, DERRICKS, HOISTS, HOOKS, JACKS, AND SLINGS

(14)

B30 STANDARD INTRODUCTION

SECTION I: SCOPE

The ASME B30 Standard contains provisions that apply to the construction, installation, operation, inspection, testing, maintenance, and use of cranes and other lifting and material-movement related equipment. For the convenience of the reader, the Standard has been divided into separate volumes. Each volume has been written under the direction of the ASME B30 Standard Committee and has successfully completed a consensus approval process under the general auspices of the American National Standards Institute (ANSI).

As of the date of issuance of this Volume, the B30 Standard comprises the following volumes:

- B30.1 Jacks, Industrial Rollers, Air Casters, and Hydraulic Gantries
- B30.2 Overhead and Gantry Cranes (Top Running Bridge, Single or Multiple Girder, Top Running Trolley Hoist)
- B30.3 Tower Cranes
- B30.4 Portal and Pedestal Cranes
- B30.5 Mobile and Locomotive Cranes
- B30.6 Derricks
- B30.7 Winches
- B30.8 Floating Cranes and Floating Derricks
- B30.9 Slings
- B30.10 Hooks
- B30.11 Monorails and Underhung Cranes
- B30.12 Handling Loads Suspended From Rotorcraft
- B30.13 Storage/Retrieval (S/R) Machines and Associated Equipment
- B30.14 Side Boom Tractors
- B30.15 Mobile Hydraulic Cranes (withdrawn 1982 — requirements found in latest revision of B30.5)
- B30.16 Overhead Hoists (Underhung)
- B30.17 Overhead and Gantry Cranes (Top Running Bridge, Single Girder, Underhung Hoist)
- B30.18 Stacker Cranes (Top or Under Running Bridge, Multiple Girder With Top or Under Running Trolley Hoist)
- B30.19 Cableways
- B30.20 Below-the-Hook Lifting Devices
- B30.21 Lever Hoists
- B30.22 Articulating Boom Cranes
- B30.23 Personnel Lifting Systems
- B30.24 Container Cranes
- B30.25 Scrap and Material Handlers
- B30.26 Rigging Hardware
- B30.27 Material Placement Systems
- B30.28 Balance Lifting Units
- B30.29 Self-Erecting Tower Cranes
- B30.30 Ropes¹

SECTION II: SCOPE EXCLUSIONS

Any exclusion of, or limitations applicable to the equipment, requirements, recommendations, or operations contained in this Standard are established in the affected volume's scope.

SECTION III: PURPOSE

The B30 Standard is intended to

- (a) prevent or minimize injury to workers, and otherwise provide for the protection of life, limb, and property by prescribing safety requirements
- (b) provide direction to manufacturers, owners, employers, users, and others concerned with, or responsible for, its application
- (c) guide governments and other regulatory bodies in the development, promulgation, and enforcement of appropriate safety directives

SECTION IV: USE BY REGULATORY AGENCIES

These volumes may be adopted in whole or in part for governmental or regulatory use. If adopted for governmental use, the references to other national codes and standards in the specific volumes may be changed to refer to the corresponding regulations of the governmental authorities.

SECTION V: EFFECTIVE DATE

(a) *Effective Date.* The effective date of this Volume of the B30 Standard shall be 1 yr after its date of issuance.

¹ This volume is currently in the development process.

Construction, installation, inspection, testing, maintenance, and operation of equipment manufactured and facilities constructed after the effective date of this Volume shall conform to the mandatory requirements of this Volume.

(b) *Existing Installations.* Equipment manufactured and facilities constructed prior to the effective date of this Volume of the B30 Standard shall be subject to the inspection, testing, maintenance, and operation requirements of this Standard after the effective date.

It is not the intent of this Volume of the B30 Standard to require retrofitting of existing equipment. However, when an item is being modified, its performance requirements shall be reviewed relative to the requirements within the current volume. The need to meet the current requirements shall be evaluated by a qualified person selected by the owner (user). Recommended changes shall be made by the owner (user) within 1 yr.

SECTION VI: REQUIREMENTS AND RECOMMENDATIONS

Requirements of this Standard are characterized by use of the word *shall*. Recommendations of this Standard are characterized by the word *should*.

SECTION VII: USE OF MEASUREMENT UNITS

This Standard contains SI (metric) units as well as U.S. Customary units. The values stated in U.S. Customary units are to be regarded as the standard. The SI units are a direct (soft) conversion from the U.S. Customary units.

SECTION VIII: REQUESTS FOR REVISION

The B30 Standard Committee will consider requests for revision of any of the volumes within the B30 Standard. Such requests should be directed to

Secretary, B30 Standard Committee
ASME Codes and Standards
Two Park Avenue
New York, NY 10016-5990

Requests should be in the following format:

- Volume: Cite the designation and title of the volume.
Edition: Cite the applicable edition of the volume.
Subject: Cite the applicable paragraph number(s) and the relevant heading(s).
Request: Indicate the suggested revision.
Rationale: State the rationale for the suggested revision.

Upon receipt by the Secretary, the request will be forwarded to the relevant B30 Subcommittee for consideration and action. Correspondence will be provided to

the requester defining the actions undertaken by the B30 Standard Committee.

SECTION IX: REQUESTS FOR INTERPRETATION

The B30 Standard Committee will render an interpretation of the provisions of the B30 Standard. Such requests should be directed to

Secretary, B30 Standard Committee
ASME Codes and Standards
Two Park Avenue
New York, NY 10016-5990

Requests should be in the following format:

- Volume: Cite the designation and title of the volume.
Edition: Cite the applicable edition of the volume.
Subject: Cite the applicable paragraph number(s) and the relevant heading(s).
Question: Phrase the question as a request for an interpretation of a specific provision suitable for general understanding and use, not as a request for approval of a proprietary design or situation. Plans or drawings that explain the question may be submitted to clarify the question. However, they should not contain any proprietary names or information.

Upon receipt by the Secretary, the request will be forwarded to the relevant B30 Subcommittee for a draft response, which will then be subject to approval by the B30 Standard Committee prior to its formal issuance.

Interpretations to the B30 Standard will be published in the subsequent edition of the respective volume, and will be available online at <http://cstools.asme.org/>.

SECTION X: ADDITIONAL GUIDANCE

The equipment covered by the B30 Standard is subject to hazards that cannot be abated by mechanical means, but only by the exercise of intelligence, care, and common sense. It is therefore essential to have personnel involved in the use and operation of equipment who are competent, careful, physically and mentally qualified, and trained in the proper operation of the equipment and the handling of loads. Serious hazards include, but are not limited to, improper or inadequate maintenance, overloading, dropping or slipping of the load, obstructing the free passage of the load, and using equipment for a purpose for which it was not intended or designed.

The B30 Standard Committee fully realizes the importance of proper design factors, minimum or maximum dimensions, and other limiting criteria of wire rope or chain and their fastenings, sheaves, sprockets, drums, and similar equipment covered by the standard, all of

which are closely connected with safety. Sizes, strengths, and similar criteria are dependent on many different factors, often varying with the installation and uses. These factors depend on

- (a) the condition of the equipment or material
- (b) the loads
- (c) the acceleration or speed of the ropes, chains, sheaves, sprockets, or drums
- (d) the type of attachments

(e) the number, size, and arrangement of sheaves or other parts

(f) environmental conditions causing corrosion or wear

(g) many variables that must be considered in each individual case

The requirements and recommendations provided in the volumes must be interpreted accordingly, and judgment used in determining their application.

ASME B30.21-2014

SUMMARY OF CHANGES

Following approval by the ASME B30 Committee and ASME, and after public review, ASME B30.21-2014 was approved by the American National Standards Institute on January 27, 2014.

ASME B30.21-2014 includes editorial changes, revisions, and corrections identified by a margin note, (14).

<i>Page</i>	<i>Location</i>	<i>Change</i>
viii–x	B30 Standard Introduction	Revised
1–7	Section 21-0.1	Revised
	Figure 21-0.1-1	Title revised
	Figure 21-0.1-2	Title and figure revised
	Figure 21-0.1-3	Title revised
	Section 21-0.2	(1) Definitions of <i>administrative or regulatory authority; ambient temperature; appointed; designated person; exposed; guide, web strap; guide, wire rope; and lifting devices</i> deleted (2) Definitions of <i>block, load; chain, rollerless; drum; guide (formerly guide, chain); headroom; lift; load; load, rated; overtravel restraint; parts (lines); pawl; reeving; service, normal; sheave; side pull; sprocket idler; and sprocket, load</i> revised (3) Definition of <i>minimum breaking force</i> added
	Figure 21-0.2-1	Title and figure revised
	Figure 21-0.2-2	Caption for illustration (a) revised
	Figure 21-0.2-4	Illustration (a) revised
	Figure 21-0.2-5	Revised
	Section 21-0.3	Added
	Section 21-0.4	Formerly 21-0.3, redesignated and updated
8–10	Chapter 21-1	(1) Title revised and chapter revised in its entirety (2) Table 1 deleted
11–15	Chapter 21-2	(1) Revised in its entirety (2) Table 2 revised and redesignated as Tables 21-2.1.4-1 and 21-2.1.5-1
16, 17	Chapter 21-3	(1) Revised in its entirety (2) Table 3 deleted
18–20	Chapter 21-4	Added

SPECIAL NOTE:

The interpretations to ASME B30.21 are included in this edition as a separate section for the user's convenience.

LEVER HOISTS

Chapter 21-0

Scope, Definitions, Personnel Competence, and References

(14) SECTION 21-0.1: SCOPE OF ASME B30.21

Volume B30.21 includes provisions that apply to the construction, installation, operation, inspection, and maintenance of ratchet and pawl and friction brake type lever chain, rope, and web strap hoists used for lifting, pulling, and tensioning applications (see Figs. 21-0.1-1, 21-0.1-2, and 21-0.1-3).

The requirements for a lever hoist that is used for a special purpose, such as lifting personnel or drawing both the load and the hoist up or down the load chain, rope, or web strap when the lever hoist is attached to the load, and a specially insulated hoist used for handling energized electrical power lines are not included in this Volume.

(14) SECTION 21-0.2: DEFINITIONS

abnormal operating conditions: environmental conditions that are unfavorable, harmful, or detrimental to or for the operation of a hoist, such as excessively high or low ambient temperatures, exposure to weather, corrosive fumes, dust laden or moisture laden atmospheres, and hazardous locations.

block, load: the assembly of hook or shackle, swivel, bearings, sheaves, sprockets, pins, and frame suspended by the load chain, rope, or web strap. This shall include any appurtenances reeved in the load chain, rope, or web strap (see Fig. 21-0.2-1).

brake: a device for retarding and stopping motion of the load (see *load controlling mechanism*).

chain, load: the load-bearing chain in a hoist.

chain, roller: a series of alternately assembled roller links and pin links in which the pins articulate inside the bushings and the rollers are free to turn on the bushings. Pins and bushings are press fit in their respective link plates (see Fig. 21-0.2-2). Rollerless chain may be provided on some equipment.

chain, rollerless: a series of alternately assembled roller links and pin links in which the pins articulate inside the bushings with rollers on the bushings omitted. Pins

and bushings are press fit in their respective link plates (see Fig. 21-0.2-2).

chain, welded link: a chain consisting of a series of interwoven links formed and welded (see Fig. 21-0.2-2).

drum: the cylindrical member around which the rope or web strap is wound for lifting and lowering the load.

friction brake: see *load controlling mechanism*.

guide: a means to guide the load chain, rope, or web strap at the load sprocket (drum) [see Figs. 21-0.2-3 and 21-0.2-4, illustration (b)].

hazardous (classified) locations: locations where fire or explosion hazards may exist. Locations are classified according to the properties of the flammable vapors, liquids, gases, or combustible dust or fibers that may be present, and the likelihood that a flammable or combustible concentration or quantity is present (see ANSI/NFPA 70).

headroom (closed height): the distance between the saddle of the suspension hook and the saddle of the load hook when the load block is in its fully retracted position [see Fig. 21-0.2-1, illustration (a)].

hoist, lever: a manual lever-operated device used to lift, lower, or pull a load and to apply or release tension.

hook latch: a mechanical device to bridge the throat opening of a hook.

lift: the maximum distance through which the load hook can travel [see Fig. 21-0.2-1, illustration (a)].

load: the total superimposed force on the hoist load block or hook.

load, rated: the maximum load that shall be applied to the hoist as specified by the manufacturer or a qualified person.

load controlling mechanism: a mechanism that functions automatically to hold and control the load. In each of the following general types, a reciprocating force must be applied to the hoist lever to lower the load.

friction brake type: an automatic type of brake used for holding and controlling loads. This unidirectional device requires a force applied to the operating lever to lower

(14)

Fig. 21-0.1-1 Lever Hoist – Chain Type

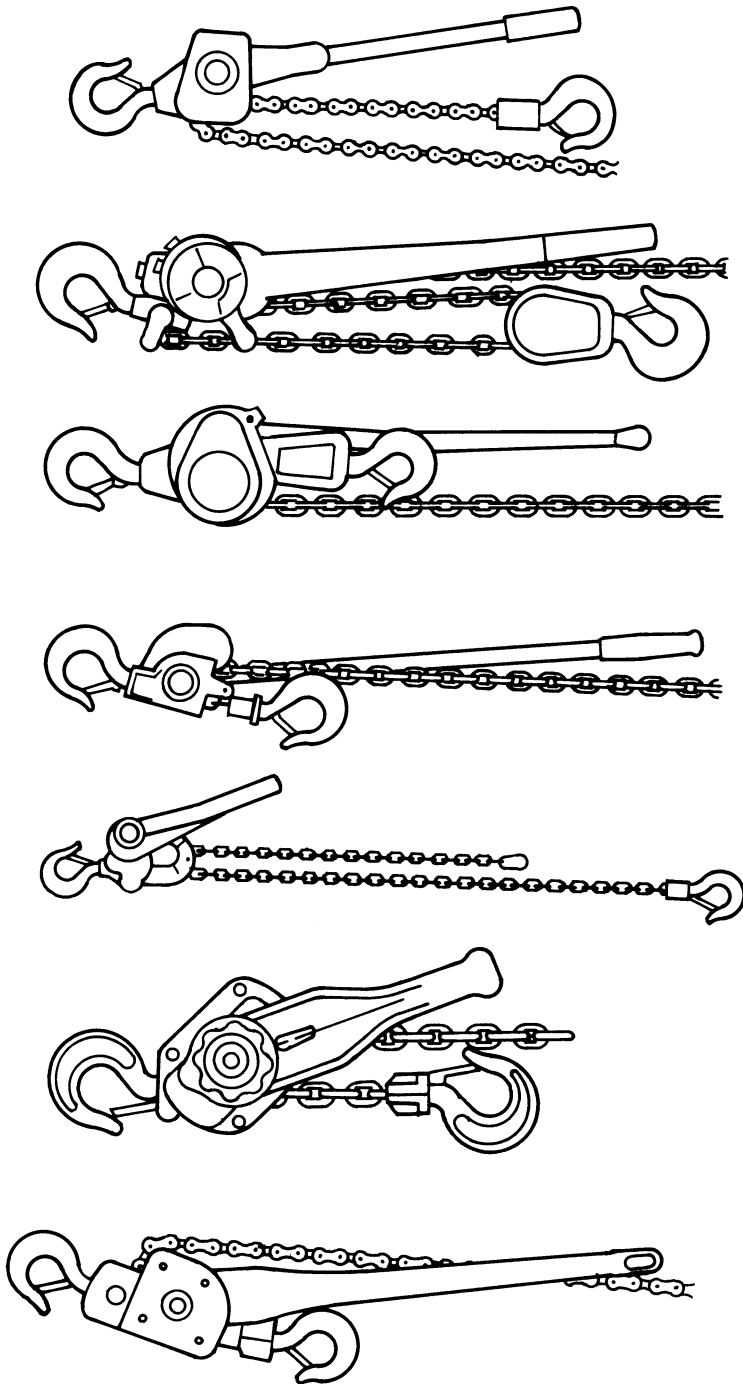

Fig. 21-0.1-2 Lever Hoist — Rope

(14)

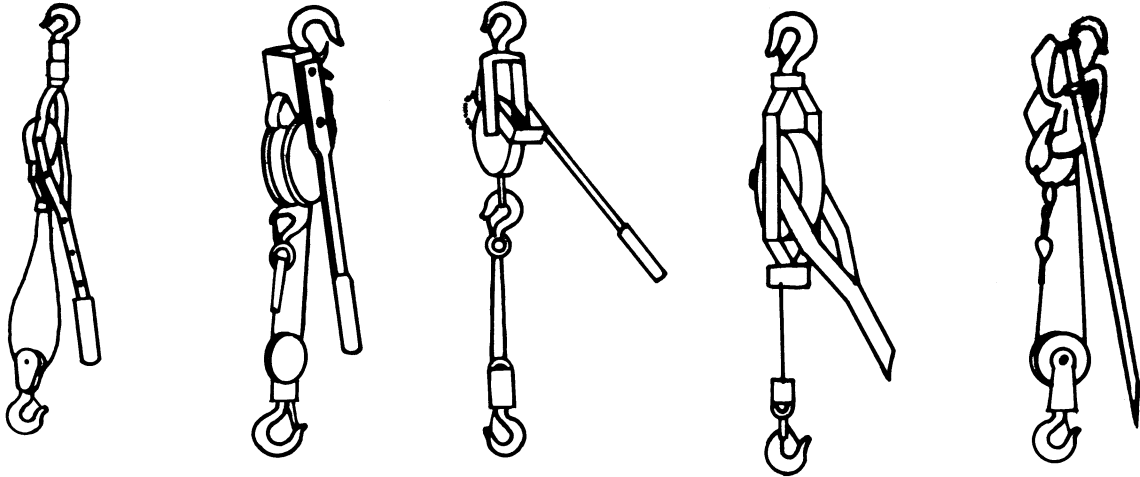

Fig. 21-0.1-3 Lever Hoist — Web Strap

(14)

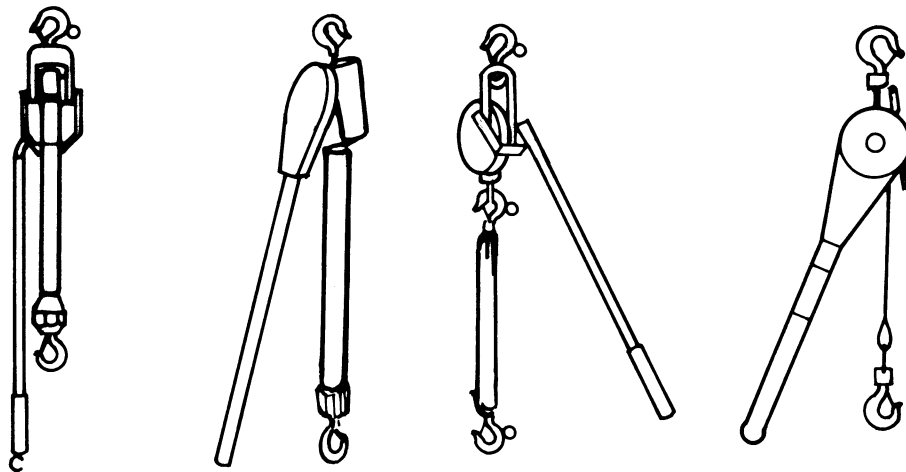
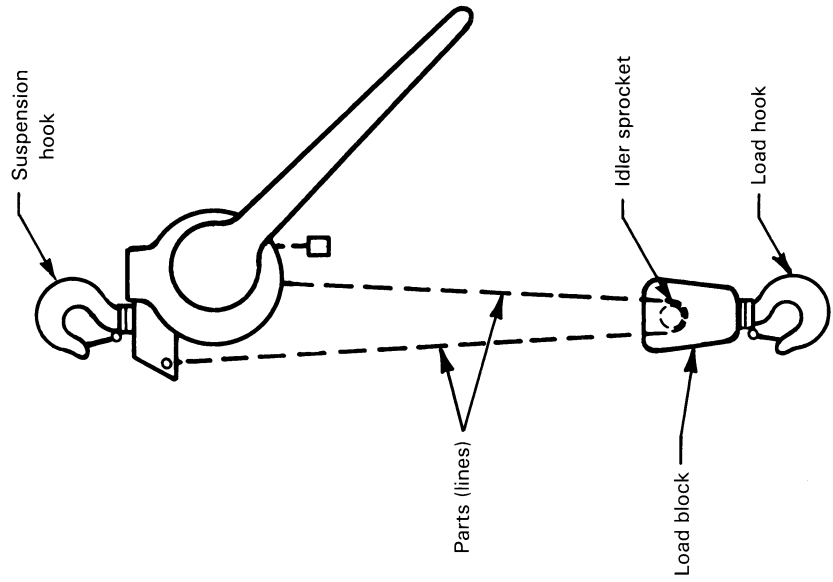
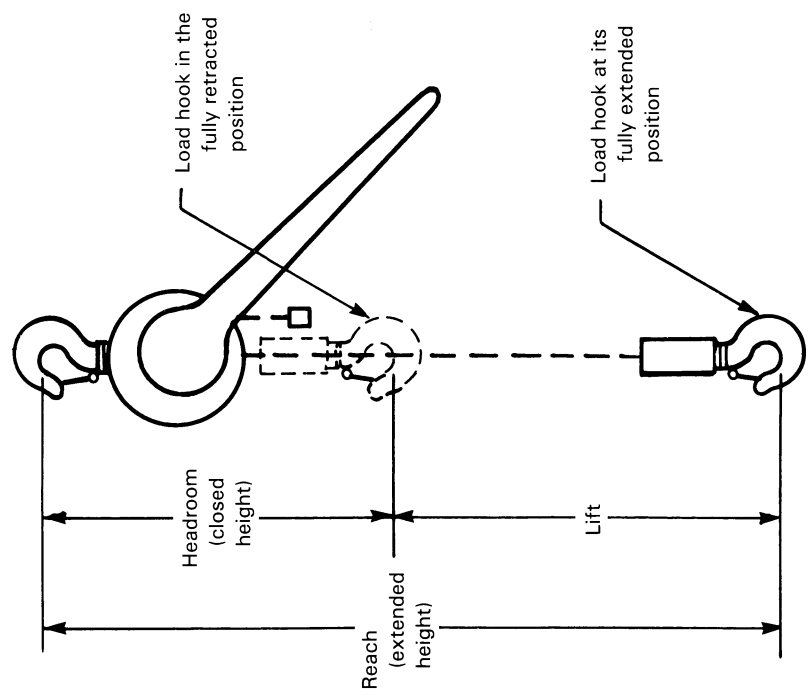

Fig. 21-0.2-1 Lever Hoist — Chain Type



(b) Multiple Reeved (Two Parts)



(a) Single Reeved (One Part)

(14)

Fig. 21-0.2-2 Load Chain

(14)

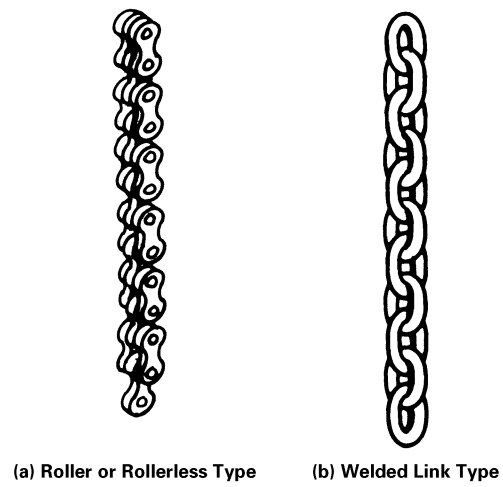
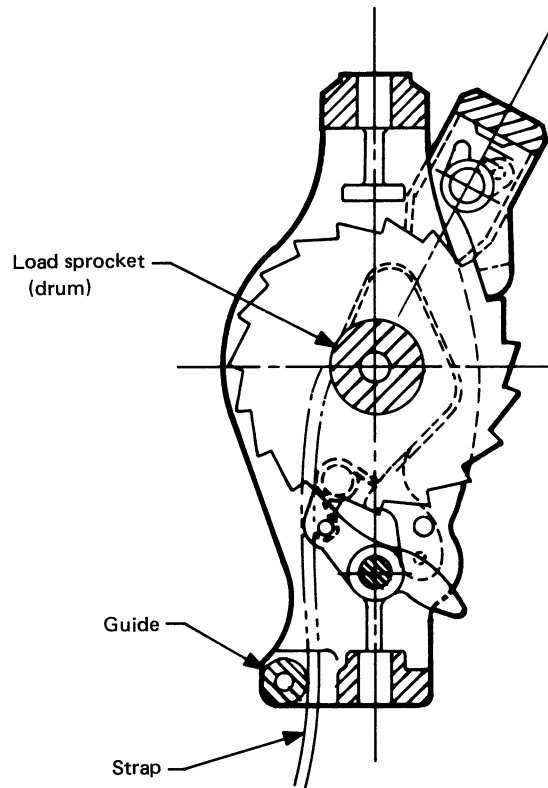
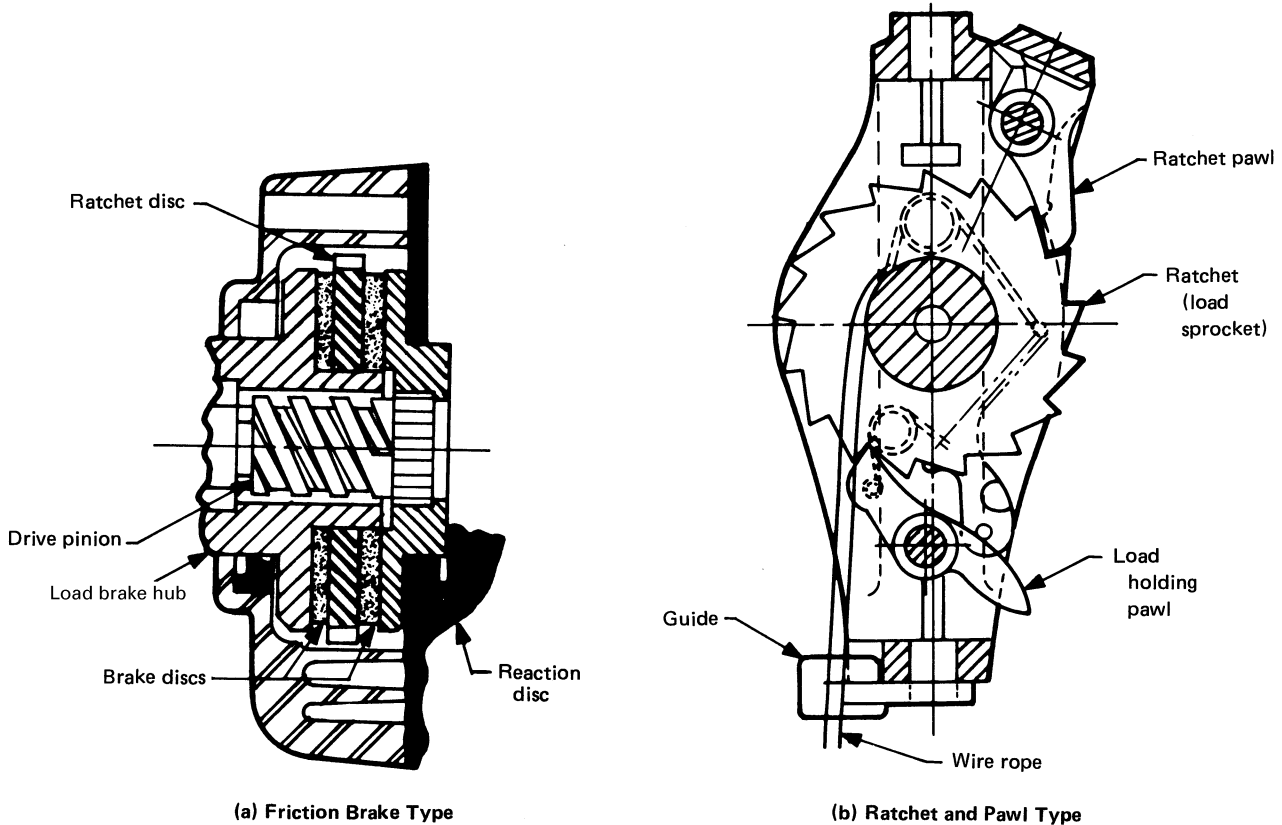

Fig. 21-0.2-3 Guide and Load Sprocket-Strap



(14)

Fig. 21-0.2-4 Load Controlling Mechanism



the load, but does not impose additional lever pull when lifting the load [see Fig. 21-0.2-4, illustration (a)].

ratchet and pawl type: a load controlling mechanism consisting of interlocking pawl(s) and ratchet that act to hold the load by mechanical engagement [see Fig. 21-0.2-4, illustration (b)].

load hook: the hook used to connect the load to the hoist.

minimum breaking force: the minimum load at which a new and unused rope will break when loaded to destruction in direct tension.

normal operating conditions: conditions during which a hoist is performing functions within the scope of the original design.

operating lever: the lever or handle provided to operate the hoist.

overload: any load greater than the rated load.

overtravel restraint: a device used to prevent the slack load chain, rope, or web strap from inadvertently being extended out of the load sprocket (drum) (see Fig. 21-0.2-5 for example of chain type).

parts (lines): number of lines of chain, rope, or web strap supporting the load block or hook [see Fig. 21-0.2-1, illustration (b)].

Fig. 21-0.2-5 Overtravel Restraint

(14)



pawl: a device that engages the ratchet to prevent rotation [see Fig. 21-0.2-4, illustration (b)].

qualified person: a person who, by possession of a recognized degree in an applicable field, or certificate of professional standing or who, by extensive knowledge, training, and experience, has successfully demonstrated the ability to solve or resolve problems relating to the subject matter and work.

ratchet: a toothed member for engagement with the pawl [see Fig. 21-0.2-4, illustration (b)].

reeving: a system in which the chain, rope, or web strap travels around sprockets (drums) and sheaves (see Fig. 21-0.2-1).

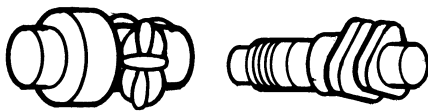
Fig. 21-0.2-6 Load Sprockets**(a) Link Chain Pocket Type****(b) Roller Chain Tooth Type**

rope: refers to wire rope unless otherwise specified.

service, heavy: service that involves operation within the rated load limit, which exceeds normal service.

service, normal: service that involves operation with randomly distributed loads within the rated load limit, or uniform loads less than 65% of rated load for not more than 15% of the time.

service, severe: service that involves normal or heavy service with abnormal operating conditions.

shall: this word indicates that the rule is mandatory and must be followed.

sheave: a grooved wheel or pulley used with a chain, rope, or web strap to change direction and point of application of a pulling force.

should: this word indicates that the rule is a recommendation, the advisability of which depends on the facts in each situation.

side pull: any force or operating condition that restricts the load block, chain, rope, or web strap, and hoist body from forming a straight line with the direction of loading.

sprocket, idler: a freely rotating device that changes the direction of the load chain, rope, or web strap (see Fig. 21-0.2-1).

sprocket, load: a hoist component that transmits motion to the load chain, rope, or web strap. This component is sometimes called the load wheel, load sheave, pocket wheel, chain wheel, or drum (see Fig. 21-0.2-6).

strap, web: a fabric woven of high tenacity synthetic yarns (see Fig. 21-0.2-3).

stripper: a device that aids the load chain in leaving the load sprocket.

unattended: a condition in which the operator of a hoist is not at the operating lever. If the hoist is within an unobstructed distance of 26 ft (8.0 m) and within sight of the operator, the hoist should be considered attended.

SECTION 21-0.3 PERSONNEL COMPETENCE (14)

Persons performing the functions identified in this Volume shall meet the applicable qualifying criteria stated in this Volume and shall through education, training, experience, skill, and physical fitness, as necessary, be competent and capable to perform the functions as determined by the employer or employer's representative.

SECTION 21-0.4: REFERENCES (14)

The following is a list of publications referenced in this Standard.

ANSI/NFPA 70-2011, National Electrical Code¹
 Publisher: National Fire Protection Association (NFPA),
 One Batterymarch Park, Quincy, MA 02169
 (www.nfpa.org)

ANSI Z535.4-2011, Product Safety Signs and Labels¹
 Publisher: National Electrical Manufacturers
 Association (NEMA), 1300 North 17th Street, Rosslyn,
 VA 22209 (www.nema.org)

ASME B29.24-2002 (R2009), Roller Load Chains for
 Overhead Hoists

ASME B30.10-2009, Hooks

ASME HST-3-1999 (R2010), Performance Standard for
 Manually Lever-Operated Chain Hoists

Publisher: The American Society of Mechanical
 Engineers (ASME), Two Park Avenue, New York, NY
 10016; Order Department: 22 Law Drive, P.O. Box
 2900, Fairfield, NJ 07007 (www.asme.org)

ISO 7000:2012, Graphical symbols for use on equip-
 ment — Registered symbols

ISO 7296-1:1991, Cranes — Graphical symbols — Part 1:
 General

Publisher: International Organization for
 Standardization (ISO), Central Secretariat, 1, ch. de
 la Voie-Creuse, Case postale 56, CH-1211 Genève 20,
 Switzerland/Suisse (www.iso.org)

¹ May also be obtained from the American National Standards
 Institute, 25 West 43rd Street, New York, NY 10036.

(14)

Chapter 21-1

Construction and Installation

SECTION 21-1.1: MARKING

21-1.1.1 Rated Load

The rated load of the hoist shall be marked on the hoist or load block.

21-1.1.2 Controls

Each control of a lever hoist shall be marked to indicate the direction of resultant motion.

21-1.1.3 Identification

The hoist shall be marked on a plate or label attached to the hoist, or cast, forged, or stamped on the hoist with manufacturer's identification as follows:

- (a) name of manufacturer
- (b) manufacturer's model or serial number

21-1.1.4 Product Safety Information

A label or labels shall be affixed to the hoist or load block displaying information concerning operating procedures. The label or labels shall be in compliance with ANSI Z535.4 and shall include cautionary language relating to hazards, such as the following:

- (a) lifting more than the rated load
- (b) operating the hoist when it is restricted from forming a straight line with the direction of loading
- (c) operating the hoist with a twisted, kinked, or damaged chain, rope, or web strap
- (d) operating a damaged or malfunctioning hoist
- (e) lifting people
- (f) lifting loads over people
- (g) operating a hoist with lever extension
- (h) removing or obscuring the warning label

SECTION 21-1.2: CONSTRUCTION

21-1.2.1 Mechanical Design

(a) The hoist and appurtenances shall be designed to withstand all stresses imposed under normal operating conditions while handling loads within the rated load.

(b) Load suspension parts of lever hoists shall be designed so that the calculated static stress for the rated load shall not exceed 25% of the minimum ultimate tensile strength. Elements specifically intended to give visible warning of severe overload by permanent deformation while operating the hoist should be designed to show obvious deformation before failure of other load suspension parts.

(c) Modifications to upgrade, rerate, or modernize hoist equipment shall be as authorized only by the original equipment manufacturer or qualified person.

(d) The hoist should be designed in accordance with applicable hoist design and performance standards. Refer to ASME HST-3.

21-1.2.2 Load Sprockets and Drums

See Fig. 21-0.2-3; Fig. 21-0.2-4, illustration (b); and Fig. 21-0.2-6.

- (a) Load sprockets and drums shall be guarded.
- (b) Load sprockets shall have pockets or teeth to allow engagement of the load chain.
- (c) Provisions shall be made to avoid jamming of the load chain, rope, or web strap within the hoist mechanism under normal operating conditions.

21-1.2.3 Load Chain

See Fig. 21-0.2-2.

(a) Load chain may be roller, rollerless, or welded-link type. Chain shall be pitched (calibrated) so as to pass over all sprockets without binding.

(b) Roller load chain shall comply with ASME B29.24.

(c) Prior to installation on the hoist, rollerless and welded link type load chain shall be proof tested by the chain or hoist manufacturer with a load at least equivalent to $1\frac{1}{2}$ times the hoist's rated load divided by the number of chain parts supporting the load.

(d) A means shall be provided to equalize the tension on all parts if a load is supported by more than one part of load chain.

(e) Welded link type load chain used in hoists covered by this Volume shall be specifically designed for this equipment. Other types of chain shall not be substituted for the welded link type load chain used in this equipment.

(f) Load chain links that pass over the hoist load sprocket on edge (alternate to those that lie flat in the pockets) shall be installed with the welds away from the center of the sprocket unless otherwise recommended by the hoist manufacturer. This precaution is not required in idler sprockets that change the direction but not the tension in the chain.

21-1.2.4 Rope

(a) Rope shall be of a construction specified by the hoist manufacturer or a qualified person.

(b) A means shall be provided to equalize the tension on all parts if a load is supported by more than one part of rope.

(c) Socketing shall be done in the manner specified by the hoist manufacturer, rope manufacturer, or a qualified person.

(d) Eye splices shall be made in a manner recommended by the hoist manufacturer, rope manufacturer, or a qualified person. Rope thimbles should be used in the eye.

(e) Swaged or compressed fittings shall be applied as recommended by the rope, hoist, or fitting manufacturer or a qualified person.

(f) The rope ends shall be attached to the hoist in a manner to prevent disengagement throughout hook travel. No less than two wraps of rope shall remain on the hoist load sprocket (drum) when the hoist is in its fully extended position.

(g) Wherever exposed to ambient temperatures at the rope in excess of 180°F (82°C), rope having an independent wire-rope core, wire-strand core, or other temperature damage-resistant core shall be used.

(h) When the rope may be exposed to an environmental condition under which the rope or core would be damaged, a rope and core having resistance to the conditions shall be used.

21-1.2.5 Web Strap

(a) The web strap shall be of a construction specified by the hoist manufacturer or a qualified person for the application intended.

(b) A means shall be provided to equalize the tension on all parts if a load is supported by more than one part of web strap.

(c) End terminations shall be done in the manner specified by the hoist manufacturer, web strap manufacturer, or a qualified person.

(d) Eyes shall be made in a manner recommended by the hoist manufacturer, web strap manufacturer, or a qualified person.

(e) The web strap shall be attached to the hoist in a manner to prevent disengagement throughout hook travel. No less than two wraps of web strap shall remain on the hoist load sprocket (drum) when the hoist is in its fully extended position.

21-1.2.6 Hooks

If hooks are of the swiveling type, they should rotate freely (see Fig. 21-1.2.6-1). Hooks shall be equipped with latches unless the use of the latch creates a hazardous condition. The latch shall bridge the throat opening of the hook for the purpose of retaining slings, shackles, etc. under slack conditions. The latch is not intended to support the load. Refer to ASME B30.10.

Fig. 21-1.2.6-1 Swivel Type Hook

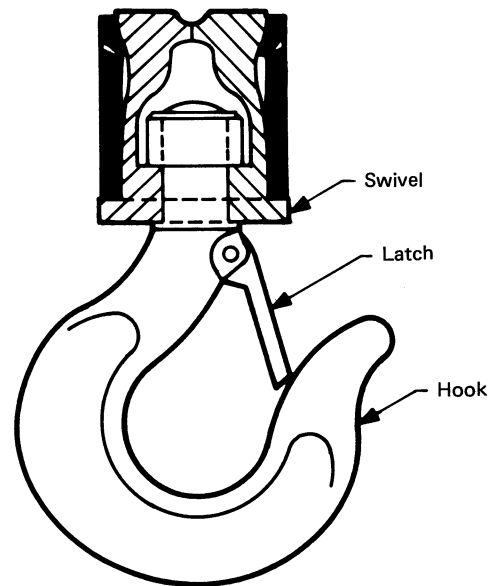

21-1.2.7 Load Blocks

Means shall be provided to guard against jamming of the load chain, rope, or web strap in the load block under normal operating conditions.

21-1.2.8 Load Controlling Mechanism

The hoist shall be equipped with a load controlling mechanism that shall perform the following functions under normal operating conditions with test loads up to 125% of rated load:

(a) Stop and hold the load when the lever force is removed and the lever stroke is completed.

(b) Provide for incremental movement of the load when lifting or lowering.

(c) The friction brake mechanism shall have provision for adjustment where necessary to compensate for wear.

21-1.2.9 Overtravel Restraint

The load chain shall be restrained before it can be completely run out of the hoist. The restraint shall be such that the unloaded hoist can withstand a lowering operating lever force of twice the force required to lift the rated load, or the hoist with rated load can withstand a lowering operating lever force equivalent to the force required to lift the rated load.

21-1.2.10 Convertible Load Rating

On hoists with a convertible load rating feature, the rated load is converted by changing the number of parts (lines) supporting the load [see Fig. 21-0.2-1, illustration (b)]. This conversion shall be accomplished as recommended by the manufacturer without the use of additional components that are not furnished with the hoist.

21-1.2.11 Lubrication

If lubrication is required, a means of access for lubrication shall be provided.

21-1.2.12 Manual

The manufacturer shall furnish an instruction manual with each hoist. The manual shall include information on the following:

- (a) operation
- (b) inspection and testing
- (c) lubrication, maintenance, and repair

SECTION 21-1.3: TRANSLATION**21-1.3.1 Translation of Non-English Documentation Into English**

(a) The wording of written non-English safety information and manuals regarding use, inspection, and maintenance shall be translated into English by professional translation industry standards, which include but are not limited to the following:

(1) translation of the complete paragraph message, instead of word by word

- (2) grammatical accuracy
- (3) respectfulness of the source document content without omitting or expanding the text
- (4) accurate translation of the terminology
- (5) reflection of the level of sophistication of the original document

(b) The finished translation shall be verified for compliance with paras. 21-1.3.1(a)(1) through (a)(5) by a qualified person having an understanding of the technical content of the subject matter.

(c) Pictograms used to identify controls shall be described in the manuals. The pictograms should comply with ISO 7000, ISO 7296, or other recognized source, if previously defined. The text of the description shall meet the criteria of paras. 21-1.3.1(a) and (b).

21-1.3.2 Other Translations

Any non-English documentation provided in addition to English shall be translated and reviewed in accordance with the requirements listed in para. 21-1.3.1.

Chapter 21-2

Inspection and Testing

SECTION 21-2.1: INSPECTION

21-2.1.1 General

(a) All inspections shall be performed by a designated person in accordance with the manufacturer's recommendations and with the requirements of this Volume. Any deficiencies identified shall be examined and a determination made by a qualified person as to whether they constitute hazards and whether a more detailed inspection or disassembly is required.

(b) *Inspection Frequency.* The intervals shall be determined by a qualified person based on intended operating conditions and their effects on critical hoist components.

21-2.1.2 Inspection Classification

(a) *Initial Inspection.* When being placed in service, all new, altered, or modified hoists shall be inspected per the frequent inspection requirements in para. 21-2.1.4.

(b) *Preoperation Inspection.* Visual inspection performed before the first use of each shift with records not required.

(c) *Frequent Inspection.* Visual inspection with records not required.

- (1) normal service — monthly
- (2) heavy service — weekly to monthly
- (3) severe service — daily to weekly

(d) *Periodic Inspection.* Documented visual inspection to provide the basis for a continuing evaluation. An external coded mark on the hoist is an acceptable identification in lieu of records. (A metal stamp mark shall not be made in a highly stressed area.)

- (1) normal service — yearly
- (2) heavy service — semiannually
- (3) severe service — quarterly

(e) *Hoists Not in Regular Service*

(1) A hoist that has been idle for a period of 1 mo or more but less than 1 yr shall be inspected in accordance with para. 21-2.1.4 before it is placed in service.

(2) A hoist that has been idle for a period of 1 yr or more shall be inspected in accordance with para. 21-2.1.5 before it is placed in service.

21-2.1.3 Preoperation Inspection

At a minimum, the following items shall be inspected:

(a) operating mechanisms for proper operation, proper adjustment, and unusual sounds

(b) hooks, including latches when provided, in accordance with ASME B30.10, Frequent Inspection (paras. 10-1.10.3 and 10-2.10.3)

(c) load chain, rope, or web strap for gross damage (see Section 21-2.2)

(d) load chain, rope, or web strap reeving

(e) overtravel restraint for proper attachment

(f) hoist body and lever for deformation, cracks, and/or other damage

(g) supporting structure or trolley, if used, for evidence of damage

21-2.1.4 Frequent Inspection

See also Table 21-2.1.4-1. At a minimum, the following items shall be inspected:

(a) operating mechanisms for proper operation, proper adjustment, and for unusual sounds

(b) hooks, including latches when provided, in accordance with ASME B30.10, Frequent Inspection (paras. 10-1.10.3 and 10-2.10.3)

(c) load chain in accordance with para. 21-2.2.1 or 21-2.2.2

(d) rope in accordance with para. 21-2.2.3

(e) web straps in accordance with para. 21-2.2.4

(f) load chain, rope, or web strap reeving

(g) overtravel restraint for proper attachment

(h) hoist body and lever for deformation, cracks, and/or other damage

(i) supporting structure or trolley, if used, for evidence of damage

21-2.1.5 Periodic Inspection

See also Table 21-2.1.5-1.

(a) Periodic inspections may be performed with the hoist at its location and do not require the hoist to be disassembled.

(b) Covers and other items that allow inspection of components should be opened or removed for the inspection and then closed or replaced before restoring the hoist to normal operation.

(c) At a minimum, the following items shall be inspected:

(1) the items listed in para. 21-2.1.4

(2) hooks, including latches when provided, in accordance with ASME B30.10, Periodic Inspection (paras. 10-1.10.4 and 10-2.10.4)

(3) fasteners such as rivets and bolts for evidence of loosening

Table 21-2.1.4-1 Minimum Frequent Inspection for Lever Hoists

Item	Normal Service	Heavy Service	Severe Service
	Visual Monthly [Note (1)]	Visual Weekly to Monthly [Note (1)]	Visual Daily to Weekly [Note (1)]
Frequent Inspection (see para. 21-2.1.4)			
All functional mechanisms for maladjustment and unusual sounds	x	x	x
Hooks in accordance with ASME B30.10	x	x	x
Hook latch operation, if used	x	x	x
Load chain in accordance with paras. 21-2.2.1 and 21-2.2.2	x	x	x
Rope in accordance with para. 21-2.2.3	x	x	x
Web strap in accordance with para. 21-2.2.4	x	x	x
Load chain, rope, or web strap reeving for compliance with the recommendations of the hoist manufacturer	x	x	x
Lever for bends, cracks, etc.	x	x	x
Hoist support for damage	x	x	x

NOTE:

(1) By designated personnel with records not required.

Table 21-2.1.5-1 Minimum Periodic Inspection for Lever Hoists

Item	Normal Service	Heavy Service	Severe Service
	Record Yearly [Note (1)]	Record Semiannually [Note (2)]	Record Quarterly [Note (2)]
Periodic Inspection (see para. 21-2.1.5)			
Requirements of frequent inspection	x	x	x
Evidence of loose bolts, nuts, or rivets	x	x	x
Evidence of worn, corroded, cracked, or distorted parts such as load blocks, suspension housing, levers, chain attachments, clevises, yokes, suspension bolts, shafts, gears, bearings, pins, rollers, and locking and clamping devices	x	x	x
Evidence of damage to hook retaining nuts or collars, and pins and welds or rivets used to secure the retaining members	x	x	x
Evidence of damage or excessive wear of load sprockets or idler sprockets	x	x	x
Evidence of worn, glazed, or oil contaminated friction disks; worn pawls, cams, or ratchets; corroded, stretched, or broken pawl springs in brake mechanism	x	x	x
Label or labels required by para. 21-1.1.4	x	x	x
End connections of load chain, including overtravel restraints, rope, or web strap	x	x	x

NOTES:

- (1) Visual inspection by a designated person making records of conditions to provide the basis for a continuing evaluation.
- (2) As in Note (1) unless conditions as determined by a qualified person indicate that disassembly should be done to permit detailed inspection.

(4) components such as load blocks, suspension housings, levers, attachments, clevises, yokes, suspension bolts, shafts, gears, bearings, pins, rollers, and locking and clamping devices for evidence of wear, corrosion, cracks, and distortion

(5) load sprockets, idler sprockets, drums, and sheaves for evidence of damage and wear

(6) brake mechanisms on friction brake hoists for evidence of worn, glazed, or oil-contaminated friction disks; worn pawls, cams, or ratchets; corroded, stretched, or broken pawl springs

(7) supporting structure or trolley, if used, for evidence of damage

(8) label or labels, required by para. 21-1.1.4 for legibility and replacement

(9) end connections of load chains, rope, or web strap for evidence of deterioration, corrosion, cracks, damage, and distortion including overtravel restraints

(10) the hoist and hoist mounting for evidence of missing items

SECTION 21-2.2 LIFTING LOAD CHAIN, ROPE, OR WEB STRAP INSPECTION

21-2.2.1 Welded Link Chain Inspection

(a) Welded link chain should first be inspected while it is in the hoist with the hoist suspended in vertical position and a load of approximately 50 lb (23 kg) applied.

(1) Test the hoist under load in lifting and lowering directions, and observe the operation of the chain and sprockets. The chain should feed smoothly into and away from the sprockets.

(2) If the chain binds, jumps, or is noisy, verify that it is clean and properly lubricated. If trouble persists, inspect the chain and mating parts for wear, distortion, or other damage.

(b) Chains should be inspected over their entire length for gross damage that may be an immediate hazard, such as the following:

(1) Examine visually for gouges, nicks, weld spatter, corrosion, and distorted links (see para. 21-4.3.1 for replacement criteria).

(2) Verify the chain feeds smoothly into and away from the sprockets in lifting and lowering operations with a load.

(3) Slacken the chain and move the adjacent links to one side to inspect for wear at the contact points. If wear is observed or if stretching is suspected, the chain should be measured according to the hoist manufacturer's instructions. If instructions are not available, proceed as follows:

(a) Select an unworn, unstretched length of the chain (e.g., at the slack end).

(b) Suspend the chain vertically under tension and, using a caliper-type gage, measure the outside

length of any convenient number of links approximately 12 in. to 24 in. (305 mm to 610 mm) overall.

(c) Measure the same number of links in the used sections and calculate the percentage increase in length.

21-2.2.2 Roller and Rollerless Chain Inspection

(a) Roller and rollerless chain should first be inspected while it is in the hoist with the hoist suspended in vertical position and a load of approximately 50 lb (23 kg) applied.

(1) Test the hoist under load in lifting and lowering directions and observe the operation of the chain and sprockets. The chain should feed smoothly into and away from the sprockets.

(2) If the chain binds, jumps, or is noisy, first see that it is clean and properly lubricated. If trouble persists, inspect the chain in accordance with para. 21-2.2.2(c), and inspect mating parts for wear distortion or other damage.

(b) Chains should be inspected over their entire length for gross damage that may be an immediate hazard, such as the following:

(1) Examine visually for gouges, nicks, weld spatter, corrosion, and distorted links (see para. 21-4.4.1 for replacement criteria).

(2) Verify the chain feeds smoothly into and away from the sprockets in lifting and lowering operations with a load.

(3) Check chain for elongation following the hoist manufacturer's instructions. In absence of specific instructions, the chain can be checked by determining the normal pitch and measuring a 12-in. (305-mm) section of chain that normally travels over the load sprocket. Using a caliper-type gage, check the dimension from the edge of one chain pin to the corresponding edge of another pin for the number of pitches per foot.

(4) Check chain for twist.

(5) Check for side bow in plane perpendicular to plane of rollers.

(c) Additional inspection of the chain should be made by removing chain from hoist and cleaning it thoroughly in an acid-free solvent. A check should then be made for any of the following deficiencies:

(1) pins turned from their original position

(2) rollers that do not run freely with light finger pressure

(3) joints that cannot be flexed by easy hand pressure

(4) side plates that are spread open (a visual check of the pinhead extension at the damaged area, as compared to the pin extension at the free end of the chain, can determine the amount of spread and the condition of the chain)

(5) corrosion, pitting, or discoloration of chain (generally indicative of serious impairment)

(6) gouges, nicks, or weld spatter

21-2.2.3 Rope Inspection

Ropes should be inspected over their entire length for gross damage that may be an immediate hazard, such as the following:

- (a) distortion of the rope such as kinking, crushing, unstranding, birdcaging, main strand displacement, or core protrusion
- (b) general corrosion
- (c) broken or cut strands
- (d) in running ropes, six randomly distributed broken wires in six rope diameters or three broken wires in one strand in six rope diameters
- (e) one outer wire broken at the contact point with the core of the rope that has worked its way out of the rope structure and protrudes or loops out from the rope structure
- (f) evidence of heat damage from any cause
- (g) reduction of rope diameter due to loss of core support, internal or external corrosion
- (h) reductions from nominal diameter greater than 5%
- (i) severely corroded or broken wires at end connections
- (j) severely corroded, cracked, bent, worn, or improperly applied end connections
- (k) special care should be taken when inspecting sections of rapid deterioration, such as the following:
 - (1) sections in contact with saddles, equalizer sheaves, or other sheaves where rope travel is limited
 - (2) sections of the rope at or near terminal ends where corroded or broken wires may protrude
 - (3) sections subject to reverse bends
 - (4) sections of rope that are normally hidden during visual inspection such as parts passing over sheaves

21-2.2.4 Web Strap Inspection

(a) Web straps should be visually inspected over their entire length for gross damage that may be an immediate hazard, such as the following:

- (1) melting or charring
- (2) acid or caustic burns
- (3) weld spatter
- (4) broken stitching
- (5) cuts or tears
- (6) damaged eyes or fittings
- (7) abrasive wear
- (8) knots
- (9) discoloration, brittle fibers, and hard or stiff areas that may indicate ultraviolet damage

(b) Special care should be taken when inspecting sections for rapid deterioration, such as the following:

- (1) sections in contact with saddles, equalizer sheaves, or other sheaves where web strap travel is limited
- (2) sections of the web strap at or near terminal ends where broken threads or cuts may be evident
- (3) sections subject to reverse bends
- (4) sections of web strap that are normally hidden during visual inspection such as parts passing over sheaves

SECTION 21-2.3: TESTING

21-2.3.1 Operational Tests

All new hoists shall be tested by the hoist manufacturer. All altered or repaired hoists, or hoists that have been placed in service that have not been used within the preceding 12 mo shall be tested by, or under the direction of, a designated person to ensure compliance with the requirements of with this Volume, including the following:

- (a) All functions of the hoist shall be checked with the hoist suspended in the unloaded state. (Some hoists may require a nominal load or pull on the load hook to test the lowering motion.)
- (b) After testing in the unloaded state, a load of at least 100 lb (46 kg) times the number of load-supporting parts of chain, rope, or web strap shall be applied to the hoist in order to check proper load control.

21-2.3.2 Load Test

- (a) New hoists shall be tested by the manufacturer with a test load of at least 125% of the rated load.
- (b) A hoist in which load-suspension parts have been altered, replaced, or repaired should be statically or dynamically load tested.

(1) A qualified person shall determine the need to load test the hoist.

(2) A written report of the test should be prepared and placed on file.

(3) The test load shall not be less than 100% of the rated load of the hoist or more than 125% of the rated load of the hoist unless otherwise recommended by the hoist manufacturer or a qualified person.

(4) The replacement of chain, rope, or web strap is specifically excluded from this load test; however, an operational test of the hoist should be made in accordance with para. 21-2.3.1 prior to placing the hoist back in service.

(c) Test anchorages or suspensions shall be approved by a qualified person.

(14)

Chapter 21-3

Operation and Operator Training

SECTION 21-3.1: TRAINING

When the lever hoist is a component of equipment addressed by another B30 volume, the operator training requirements of that volume shall apply in addition to the requirements of this Volume.

Lever hoist operators shall be trained in the selection, inspection, operation, cautions to personnel, effects of environment, and rigging practices, as covered by this Chapter and other volumes of the B30 Standard, where lever hoists are used, as listed in Section 21-0.4.

21-3.1.1 Sources of Operator Training

Examples of sources of training material are as follows:

- (a) information outlined in the manual provided with the equipment
- (b) information available from trade associations
- (c) government training resources such as the Department of Labor
- (d) organized labor groups
- (e) courses, seminars, and literature offered by manufacturers of lever hoists, consultants, trade schools, continuing education schools, and employers
- (f) requirements and recommendations found in national consensus standards such as this Volume

SECTION 21-3.2 HOISTING PRACTICES FOR OPERATORS

Safe operation of a lever hoist involves more than pulling on the lever. Refer to the B30 Standard Introduction, which emphasizes that the use of hoists is subject to certain hazards that cannot be abated by mechanical means but only by the exercise of intelligence, care, common sense, and experience in anticipating the motions that will occur as a result of operating the controls.

21-3.2.1 Before Operating Hoist

- (a) The supporting structure or anchoring means shall have a capacity to support the load imposed by the hoist.
- (b) The operator shall be familiar with all operating controls of the hoist, and shall be instructed as to warnings on the hoist, the hoisting practices listed in this section, and the operator's manual provided by the hoist manufacturer.
- (c) If adjustments or repairs are necessary, or any defects are known, the operator shall report this promptly to the appointed person.

(d) Hoists shall be used only in locations that will allow the operator to be free of the load.

(e) The operator shall have firm footing or otherwise be secured before opening the hoist.

(f) The operator shall have adequate access to the operating lever.

(g) The operator shall not operate a hoist that bears an out-of-order sign.

(h) The operator shall not adjust or repair a hoist unless qualified to perform maintenance on the hoist.

(i) The load chain or rope shall not be used as a ground for welding.

(j) A welding electrode shall not be touched to the load chain, rope, or any other part of the hoist.

(k) Hoists shall not be operated by other than hand-power of one operator.

(l) Hoists shall not be operated with an extension on the lever.

21-3.2.2 Handling the Load

(a) The hoist chain, rope, or web strap shall not be wrapped around the load.

(b) The load shall be attached to the load hook by suitable means.

(c) The sling or other load-attaching device shall be properly seated in the base (bowl) of the hook. The hook latch shall not be allowed to support any part of the load.

(d) The load shall not be applied to the tip of the hook.

(e) Before applying the load, the operator shall be sure that the load chain, rope, or web strap is not kinked or twisted, or that multiple parts of the load chain, rope, or web strap are not twisted about each other.

(f) The hoist shall not be operated unless the load chain, rope, or web strap is properly seated.

(g) The operator shall not apply a load beyond the rated load appearing on the hoist or load block, except during properly authorized tests. The use of operator aids such as load cells, dynamometers, and scales may be used to determine the load being applied.

(h) Under no circumstances shall a hoist be used to lift or move an unknown or indeterminate load. A qualified person shall be consulted.

(i) Hoists shall not be operated until the hoist body, load block, and load chain, rope, or web strap are directly in line with the direction of loading to avoid side pull.

(j) The hoist body or frame shall not bear against any object or the supporting structure.

(k) Specific attention should be given to balancing of the load and hitching or slinging to prevent slipping of the load.

(l) The operator shall not release the hoist lever until the ratchet and pawl are engaged or the brake has set and the lever is at rest.

(m) The operator shall not engage in any activity that will divert the operator's attention while operating the hoist.

(n) The operator shall not apply a load to the hoist until the operator and all other personnel are clear of the load.

(o) The operator shall maintain sure footing and balance during hoist operation.

(p) The operator shall make sure a load clears any obstacles before moving.

(q) A load shall not be moved more than a few inches until it is well balanced in the sling or lifting device.

(r) When starting to lift or pull, the operator should move the load a few inches and then check the hoist for proper load holding action. The operation shall be continued only after the operator has verified that the hoist is operating properly.

(s) The hoist shall not be used to lift, support, or otherwise transport people.

(t) The operator should not carry loads over people.

(u) The operator should not leave a loaded hoist unattended unless specific precautions have been instituted and are in place.

(v) Care shall be exercised when removing a sling from under a landed and blocked load.

(14)

Chapter 21-4

Maintenance and Maintenance Training

SECTION 21-4.1: TRAINING

When the lever hoist is a component of equipment addressed by another B30 volume, the maintenance training requirements of that volume shall apply in addition to the requirements of this Volume.

Lever hoist maintenance personnel shall be trained in the selection, inspection, cautions to personnel, effects of environment, and rigging practices as covered by this Chapter and other volumes of the B30 Standard, where lever hoists are used, as listed in Section 21-0.4.

21-4.1.1 Sources of Maintenance Training

Examples of sources of training material are as follows:

- (a) information outlined in the manual provided with the equipment
- (b) information available from trade associations
- (c) government training resources such as the Department of Labor
- (d) organized labor groups
- (e) courses, seminars, and literature offered by manufacturers of lever hoists, consultants, trade schools, continuing education schools, and employers
- (f) requirements and recommendations found in national consensus standards such as this Volume

SECTION 21-4.2: MAINTENANCE

21-4.2.1 Preventive Maintenance

(a) A preventive maintenance program shall be established and should be

- (1) based on the recommendations outlined in the hoist manufacturer's manual
- (2) reviewed by a qualified person for the application of the hoist, when required

(b) Replacement parts shall be at least equal to the original manufacturer's specifications.

21-4.2.2 Adjustments, Repairs, and Replacements

(a) Conditions disclosed by the inspections performed in accordance with the requirements of Section 21-1.3 that are determined to be a hazard during continued operation shall be corrected by adjustment, repair, or replacement before continuing the use of the hoist.

(b) Adjustments, repairs, and replacements shall be performed by a designated person.

(c) Components shall be adjusted or repaired as needed. The following are examples:

- (1) operating mechanisms
- (2) brakes and pawls

(d) Repairs or replacements shall be made as needed. Examples are as follows:

- (1) excessively worn components such as friction disks, ratchets, pawls, and pawl springs.
- (2) critical parts including load suspension components that are cracked, broken, bent, or excessively worn.
- (3) bent, cracked, or otherwise damaged levers.
- (4) worn, corroded, or otherwise damaged load chain, rope, or web strap in accordance with paras. 21-4.3.1, 21-4.4.1, 21-4.5.1, and 21-4.6.1.
- (5) hooks showing conditions described in ASME B30.10. Repairs by welding or reshaping are not permitted.
- (6) missing or illegible warning labels.
- (7) items that are missing.

21-4.2.3 Lubrication

All moving parts of the hoist for which lubrication is specified should be regularly lubricated. Care should be taken to follow manufacturer's recommendations outlined in the hoist manufacturer's manual as to points and frequency of lubrication, and quantity and types of lubricant to be used.

SECTION 21-4.3: WELDED LINK CHAIN REPLACEMENT AND MAINTENANCE

21-4.3.1 Welded Link Chain Replacement

(a) If the used chain exceeds the hoist manufacturer's recommended length, or in the absence of such recommendation, if the used chain is 2½% longer than the unused chain, the chain shall be replaced.

(b) The existence of gouges, nicks, corrosion, weld spatter, or distorted links is sufficient reason to question chain safety and consider chain replacement. Safety in this respect depends largely upon the use of good judgment by a qualified person in evaluating the degree of deficiency.

(c) Replacement chain shall be the same size, grade, and construction as the original chain furnished by the hoist manufacturer unless otherwise recommended by the hoist manufacturer or a qualified person due to actual working conditions.

(d) Load chain links that pass over the hoist load sprocket on edge (alternate to those that lie flat in the pockets) shall be installed with the welds away from the center of the sprocket unless otherwise recommended by the hoist manufacturer. This precaution is not required on idler sprockets that change the direction but not the tension in the chain.

(e) The chain shall be installed without any twist between the hoist and an anchored end on either the loaded side or slack side.

(f) When chain is replaced, the mating parts (sprockets, guides, stripper) shall be disassembled and inspected for wear and replaced if necessary.

(g) Discarded load chains shall not be used for slings.

21-4.3.2 Welded Link Chain Maintenance

(a) Load chains and hand chains should be kept clean and free from any coating or deposit that will build up and change their dimensions or reduce flexibility. The cleaning process shall not damage these chains, and any solution used in the cleaning process shall be acid-free.

(b) Load chains articulate slowly under high-bearing pressures and should be lubricated as specified by the hoist manufacturer. Hand chains are lightly loaded and normally need little or no lubrication; however, the hoist manual should be reviewed for specific lubrication information.

(c) Repairing of load chain by welding or any other means shall not be attempted by anyone other than the chain manufacturer.

SECTION 21-4.4: ROLLER AND ROLLERLESS CHAIN REPLACEMENT AND MAINTENANCE

21-4.4.1 Roller and Rollerless Chain Replacement

(a) Roller and rollerless chains shall be replaced if any of the conditions exist as stated in paras. 21-4.4.1(b)(1) through (b)(3).

(b) The existence of any of the following conditions is reason to question chain safety and for a qualified person to give consideration for replacement. Chains are subject to hidden wear and deterioration that must be considered.

(1) If elongation exceeds $\frac{1}{4}$ in. (6.3 mm) in 12 in. (305 mm), the chain shall be replaced. For example, a $\frac{3}{4}$ in. (19 mm) pitch chain should measure 12 in. (305 mm) over 16 pitches. Chain shall be rejected if measurement over 16 pitches exceeds $12\frac{1}{4}$ in. (311 mm).

(2) If the twist in any 5-ft (1.52-m) section exceeds 15 deg, the chain shall be replaced.

(3) If a side bow exceeds $\frac{1}{4}$ in. (6.3 mm) in any 5-ft (1.52-m) section, the chain shall be replaced.

(c) Replacement chain shall be the same size, grade, and construction as the original chain furnished by the hoist manufacturer unless otherwise recommended by

the hoist manufacturer or a qualified person due to actual working conditions.

(d) When chain is replaced, the mating parts (sprockets, guides, stripper) shall be disassembled and inspected for wear and replaced if necessary.

(e) When chain is replaced, it should be reeved as outlined by the hoist manufacturer and should operate freely over all load and idler sprockets. All connecting links and chain end fastenings should be inspected and properly secured. The selection and installation of connecting links should be as outlined in the hoist manufacturer's manual or as determined by a qualified person.

(f) Discarded roller chains shall not be used for slings.

21-4.4.2 Roller and Rollerless Chain Maintenance

(a) Roller and rollerless chains should be kept clean and free from rust. Excessively dirty chains should be soaked in a clean, acid-free solvent. Chains should be agitated to ensure that all joints are free from grit and foreign matter.

(b) Chains should be lubricated as outlined in the hoist manufacturer's manual. In absence of specific lubrication instructions, the chains should be lubricated with a good grade of automotive motor oil. Never apply grease to the chain.

(c) Repairing the chain by welding or heating shall not be attempted.

SECTION 21-4.5: ROPE REPLACEMENT AND MAINTENANCE

21-4.5.1 Rope Replacement

(a) No precise rules can be given for determination of the exact time for rope replacement since many variable factors are involved. Once a rope reaches any one of the following removal criteria, it may be allowed to operate to the end of the work shift, based on the judgment of a qualified person. The rope shall be replaced prior to the equipment being used by the next work shift.

Deviation shall be allowed from the removal criteria in (1) through (7) only with written approval of the hoist manufacturer, rope manufacturer, or a qualified person.

(1) in running ropes, six randomly distributed broken wires in six rope diameters, or three broken wires in one strand in six rope diameters, except as noted in para. 21-4.5.1(a)(2)

(2) in rotation-resistant ropes, two randomly distributed broken wires in six rope diameters, or four randomly distributed broken wires in thirty rope diameters

(3) one outer wire broken at the contact point with the core of the rope that has worked its way out of the rope structure and protrudes or loops out from the rope structure

(4) kinking, crushing, birdcaging, or any other damage resulting in distortion of the rope structure

- (5) evidence of heat damage from any cause
- (6) reduction of rope diameter due to loss of core support or internal or external corrosion

(7) reductions from nominal diameter greater than 5%

(b) Broken wire removal criteria cited in this Volume applies to rope operating on multilayer drums regardless of sheave material.

(c) Attention shall be given to end connections. Upon development of two broken wires adjacent to a socketed end connection, the rope should be resocketed or replaced. Resocketing shall not be attempted if the resulting rope length will be insufficient for proper operation.

(d) Replacement rope shall have a minimum breaking force at least equal to the original rope furnished by the hoist manufacturer. Replacement connections shall have a strength rating at least as great as the original connections furnished by the hoist manufacturer. Any deviation of rope or connections from the original size, grade, or construction shall be specified by a rope manufacturer, the hoist manufacturer, or a qualified person.

21-4.5.2 Rope Maintenance

(a) Rope should be stored to prevent damage or deterioration.

(b) Rope shall be unreeled or uncoiled in a manner to avoid kinking of or inducing a twist in the rope.

(c) Before cutting rope, means shall be used to prevent unlaying of the strands.

(d) During installation, care should be taken to avoid dragging the rope in dirt or around objects that will scrape, nick, crush, or induce sharp bends.

(e) Rope should be maintained in a well-lubricated condition. Lubricant applied as part of a maintenance program shall be compatible with the original lubricant. Lubricant applied shall be of the type that does not hinder visual inspection. Those sections of rope that are located over sheaves or otherwise hidden during inspection and maintenance procedures require special attention when lubricating rope. The objective of rope

lubrication is to reduce internal friction and to prevent corrosion.

(f) Repairing of rope shall not be attempted.

SECTION 21-4.6: WEB STRAP REPLACEMENT AND MAINTENANCE

21-4.6.1 Web Strap Replacement

(a) No precise rules can be given for determination of the exact time for the replacement of web strap, since many variable factors are involved. Once a web strap reaches any one of the following removal criteria, it may be allowed to operate to the end of the work shift, based on the judgment of a qualified person. The web strap shall be replaced prior to the equipment being used by the next work shift.

- (1) severely worn end connections
- (2) distortion of the web strap structure
- (3) evidence of heat damage

(b) The web strap shall be removed from service when damage such as the following is discovered:

- (1) melting or charring
- (2) acid or caustic burns
- (3) weld spatter
- (4) broken stitching
- (5) cuts or tears
- (6) damaged eyes or fittings
- (7) abrasive wear
- (8) knots

(9) discoloration, brittle fibers, and hard or stiff areas that may indicate ultraviolet damage

21-4.6.2 Web Strap Maintenance

(a) Web strap should be stored to prevent damage and deterioration from ultraviolet exposure, dirt, oil, water, and other foreign or corrosive materials.

(b) During installation, care should be taken to avoid dragging the web strap in the dirt or around objects that will scrape, nick, cut, or induce other damage.

(c) Repairs to the webbing, thread, or splice shall not be permitted.

ASME B30.21-2014 INTERPRETATIONS

Replies to Technical Inquiries October 2009 Through October 2013

FOREWORD

This publication includes all of the written replies issued between the indicated dates by the Secretary, speaking for the ASME B30 Standards Committee, Safety Standards for Cableways, Cranes, Derricks, Hoists, Hooks, Jacks, and Slings, to inquiries concerning interpretations of technical aspects of ASME B30.21, Lever Hoists.

These replies are taken verbatim from the original letters except for a few minor typographical and editorial corrections made for the purpose of improved clarity. In some few instances, a review of the interpretation revealed a need for corrections of a technical nature; in these cases, a corrected interpretation follows immediately after the original reply.

These interpretations were prepared in accordance with the accredited ASME procedures. ASME procedures provide for reconsideration of these interpretations when or if additional information is available that the inquirer believes might affect the interpretation. Further, persons aggrieved by this interpretation may appeal to the cognizant ASME Committee or Subcommittee. ASME does not "approve," "certify," "rate," or "endorse" any item, construction, proprietary device, or activity.

Interpretation: 21-3

Subject: ASME B30.21-2005, Paras. 21-1.3.1 and 21-1.4.1

Date Issued: October 28, 2009

Question: Does the user have to perform an operational test before placing the new hoist into service?

Reply: Yes.

Interpretation: 21-4

Subject: ASME B30.21-2005, Sections 21-1.3 and 21-1.4

Date Issued: January 31, 2012

Question (1): Must new hoists that have satisfied para. 21-1.3.1(a) and section 21-1.4 and that have been in inventory for a period of 1 mo or more but less than 1 yr undergo any additional inspection or testing prior to being placed in service?

Reply: (1) No.

Question (2): Must new hoists that have satisfied para. 21-1.3.1(a) and section 21-1.4 and that have been in inventory for a period of more than 1 yr undergo any additional inspection or testing prior to being placed in service?

Reply (2): No.

Interpretation: 21-5

Subject: ASME B30.21-2005, Testing, Paras. 21-1.4.2(a) and (b)

Date Issued: October 18, 2013

Background: Testing, 21-1.4.2(a): New hoists shall be tested by the manufacturer with a test load of at least 125% of the rated load.

Question (1): What hoist functions need to be load tested?

- (a) lifting and lowering
- (b) proper load control
- (c) proper brake operation
- (d) all of the above

Reply (1): ASME B30.21 does not specify what functions are to be tested on new hoists.

Background (Questions 2–5): Testing, 21-1.4.2(b): A hoist in which load-suspension parts have been altered, replaced, or repaired should be statically or dynamically load tested.

(1) A qualified person shall determine the need to load test the hoist.

Question (2): Does the Committee endorse a hoist having parts that have been altered, replaced, or repaired be put back into service without either a static or a dynamic test?

Reply (2): ASME B30 Committee does not certify, approve, or endorse any activity.

Question (3): What is the difference between a static and a dynamic test?

Reply (3): Standard dictionary definitions should be applied.

Question (4): If a static test is chosen, does this include testing any of the “lifting and lowering functions” of the hoist and if not, what exactly is tested?

Reply (4): The Standard does not specify what functions are to be tested.

Question (5): If a dynamic test is chosen, would this definition apply, which was given as an answer to B30.16, Interpretation 16-8, December 15, 1992: “The minimum distance for lifting and lowering dynamically is the distance required for all rotating parts to make at least one revolution?”

Reply (5): No.

INTENTIONALLY LEFT BLANK

INTENTIONALLY LEFT BLANK

ASME B30.21-2014

ISBN 978-0-7918-6921-5



9 780791 869215



J12614